



ELECTRIC BOREHOLE PUMPS
ELECTROPOMPES IMMERGEES
ELETTROPOMPE SOMMERSE

E4 - 6

Poles
Pôles
Poli 2 50 Hz

Desert

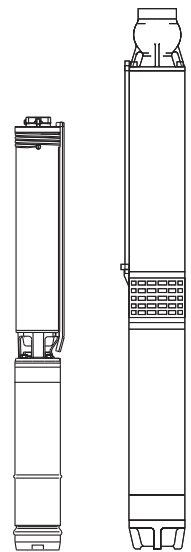

caprari

pumping power



	Page - Page - Pagina
Key to codes; <i>Explication des désignations</i> ; Esemplificazione delle sigle	3
Pump construction and materials; <i>Construction de la pompe et matériels</i> ; Costruzione pompa e materiali	4
Motor construction and materials; <i>Construction du moteur et matériels</i> ; Costruzione motore e materiali	7
General notes about the wet end; <i>Remarques générales partie hydraulique</i> ; Note generali parte idraulica	10
Motor general remarks; <i>Notes générales moteur</i> ; Note generali motore	11
Performance ranges; <i>Champs de performances</i> ; Campi di prestazioni	12
Pumps operating data, dimensions and weights; <i>Caractéristiques de fonctionnement, dimensions et poids électropompes</i> ; Caratteristiche di funzionamento, dimensioni e pesi elettropompe	13
Friction losses; <i>Pertes de charge</i> ; Perdite di carico	39
Motor operating data, dimensions and weights; <i>Caractéristiques de fonctionnement, dimensions et poids moteurs</i> ; Caratteristiche di funzionamento, dimensioni e pesi motori	40
Dynamic momentum of the wet end; <i>Moment dynamique partie hydraulique</i> ; Momento dinamico parte idraulica	46
Dynamic momentum of the motor; <i>Moment dynamique moteur</i> ; Momento dinamico motore	47
Feeding cables; <i>Câbles d'alimentation</i> ; Cavi di alimentazione	48
Generator power; <i>Puissance du generateur</i> ; Potenza del generatore	59
Common electric formulae; <i>Formules d'usage commun</i> ; Formule di uso comune	60
Electrical tolerances; <i>Tolérances électriques</i> ; Tolleranze elettriche	61
Reactive power compensation; <i>Compensation de la puissance reactive</i> ; Compensazione della potenza reattiva	62
Accessories; <i>Accessoires</i> ; Accessori	63
Technical data; <i>Donnes techniques</i> ; Dati tecnici	65

1) Electric pump code: - Désignation de l'électropompe: - Sigla elettropompa:

Ex. - Ex. - Es.

E4XED 25/31 + MCK 43-8V

E6XPD 52/3A + MAC65A-8V

E4XPD 60/13 + MCK 455-8V

E6XD 20/30 + MAC 65A - 8V

E6XDB 40/60 + MAC650B-8V

2) Examples of wet end identification codes - Identification du sigle des partie hydraulique - Esemplificazione sigle parti idrauliche

E4XED 25-4/31-V:

E4X = Series - Série - Serie _____ E4X ED 25 -4 /31 -V
 ED = Desert - Desert - Desert _____
 25 = Identification wet number - Numero identification hydraulique - Numero di identificazione idraulica _____
 -4 = Coupling flange motor 4" - Bride d'accouplement moteur 4" - Flangia accoppiamento motore 4" _____
 /31 = Number of stages - Nombre d'étages- Numero degli stadi _____
 -V = Unit used at 50 Hz - Ensemble avec utilization a 50 Hz - Gruppo con impiego a 50 Hz _____

E6XD 20-6/30-V:

E = Series - Série - Serie _____ E 6 XD 20 -6 /30 -V
 6 = DN in inch - DN en pouces - DN in pollici _____
 XD = Desert - Desert - Desert _____
 20 = Identification wet number - Numero identification hydraulique - Numero di identificazione idraulica _____
 -6 = Coupling flange motor 6" - Bride d'accouplement moteur 6" - Flangia accoppiamento motore 6" _____
 /30 = Number of stages - Nombre d'étages- Numero degli stadi _____
 -V = Unit used at 50 Hz - Ensemble avec utilization a 50 Hz - Gruppo con impiego a 50 Hz _____

E6XDB 40-6/60-V:

E = Series - Série - Serie _____ E 6 XD B 40 -6 /60 -V
 6 = DN in inch - DN en pouces - DN in pollici _____
 XD = Desert - Desert - Desert _____
 B = Intermediate casing construction - Version avec support intermediaire - Versione con supporto intermedio _____
 40 = Identification wet number - Numero identification hydraulique - Numero di identificazione idraulica _____
 -6 = Coupling flange motor 6" - Bride d'accouplement moteur 6" - Flangia accoppiamento motore 6" _____
 /60 = Number of stages - Nombre d'étages- Numero degli stadi _____
 -V = Unit used at 50 Hz - Ensemble avec utilization a 50 Hz - Gruppo con impiego a 50 Hz _____

E4XPD 60-4/13-W:

E4X = Series - Série - Serie _____ E4X PD 60 -4 /13 -W
 PD = Extra Performance Desert _____
 60 = Identification wet number - Numero identification hydraulique - Numero di identificazione idraulica _____
 -4 = Coupling flange motor 4" - Bride d'accouplement moteur 4" - Flangia accoppiamento motore 4" _____
 /13 = Number of stages - Nombre d'étages- Numero degli stadi _____
 -W = Unit used at 50/60 Hz - Ensemble avec utilization a 50/60 Hz - Gruppo con impiego a 50/60 Hz _____

E6XPD 52-6/3A-V:

E = Series - Série - Serie _____ E 6 XPD 52 -6 /3 A -V
 6 = DN in inch - DN en pouces - DN in pollici _____
 XPD = Extra Performance Desert _____
 52 = Identification wet number - Numero identification hydraulique - Numero di identificazione idraulica _____
 -6 = Coupling flange motor 6" - Bride d'accouplement moteur 6" - Flangia accoppiamento motore 6" _____
 /3 = Number of stages - Nombre d'étages- Numero degli stadi _____
 A = Impeller trimming - Rognage roue - Riduzione girante _____
 -V = Unit used at 50 Hz - Ensemble avec utilization a 50 Hz - Gruppo con impiego a 50 Hz _____

3) Examples of submersible motor identification codes - Identification du sigle des moteurs immergés - Esemplificazione sigle motori sommersi

MCK43 -8 :

MC = Submersible motor - Moteur immergé - Motore sommerso _____ MC K 4 3 -8
 K = Axial thrust - Poussée axiale - Spinta assiale _____
 4 = Nominal diameter in inches - Diamètre nominal en pouces - Diametro nominale in pollici _____
 3 = Nominal power in CV - Puissance nominale en CV - Potenza nominale in CV _____
 -8 = Constructional features of electric motor - Caractéristiques de fabrication moteur électrique - Caratteristiche costruttive motore elettrico _____

MCR455 -8

MC = Submersible motor - Moteur immergé - Motore sommerso _____ MC R 4 55 -8
 R = Axial thrust - Poussée axiale - Spinta assiale _____
 4 = Nominal diameter in inches - Diamètre nominal en pouces - Diametro nominale in pollici _____
 55 = Nominal power in CV - Puissance nominale en CV - Potenza nominale in CV _____
 -8 = Constructional features of electric motor - Caractéristiques de fabrication moteur électrique - Caratteristiche costruttive motore elettrico _____

MAC65/2A -8 :

MAC = Submersible motor - Moteur immergé - Motore sommerso _____ MAC 6 5 /2 A -8
 6 = Nominal diameter in inches - Diamètre nominal en pouces - Diametro nominale in pollici _____
 5 = Nominal power in CV - Puissance nominale en CV - Potenza nominale in CV _____
 /2 = Generational code - Code générationnel - Codice generazionale _____
 A = Hi Tech _____
 -8 = Constructional features of electric motor - Caractéristiques de fabrication moteur électrique - Caratteristiche costruttive motore elettrico _____

MAC650/2B -8 :

MAC = Submersible motor - Moteur immergé - Motore sommerso _____ MAC 6 50 /2 B -8
 6 = Nominal diameter in inches - Diamètre nominal en pouces - Diametro nominale in pollici _____
 50 = Nominal power in CV - Puissance nominale en CV - Potenza nominale in CV _____
 /2 = Generational code - Code générationnel - Codice generazionale _____
 B = Hi Tech Desert _____
 -8 = Constructional features of electric motor - Caractéristiques de fabrication moteur électrique - Caratteristiche costruttive motore elettrico _____

E4XED E4XPD

E4XPD

E4XED

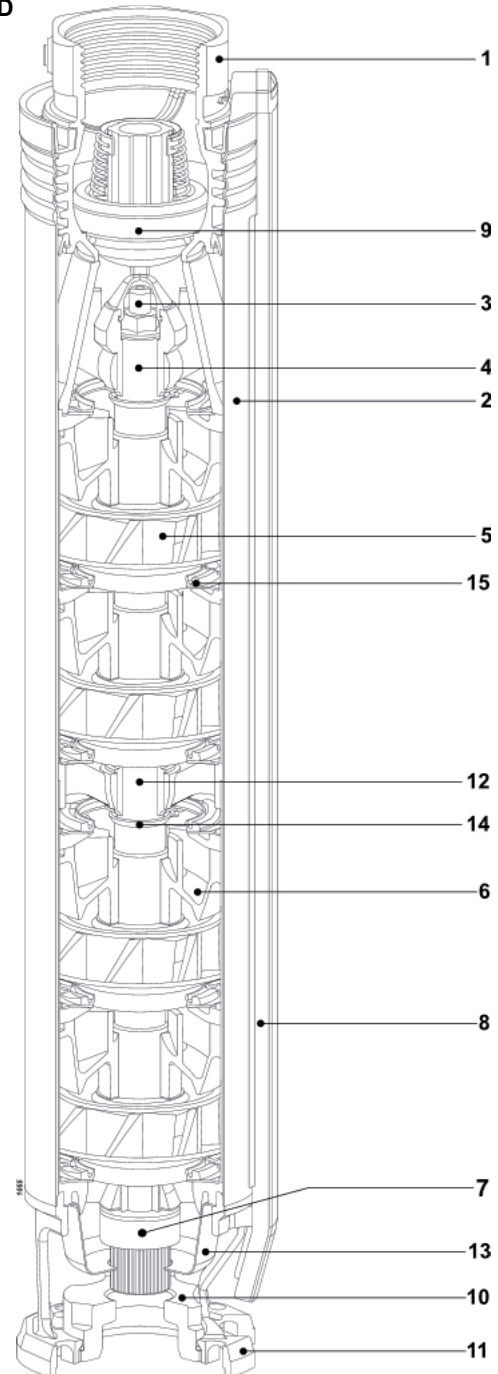
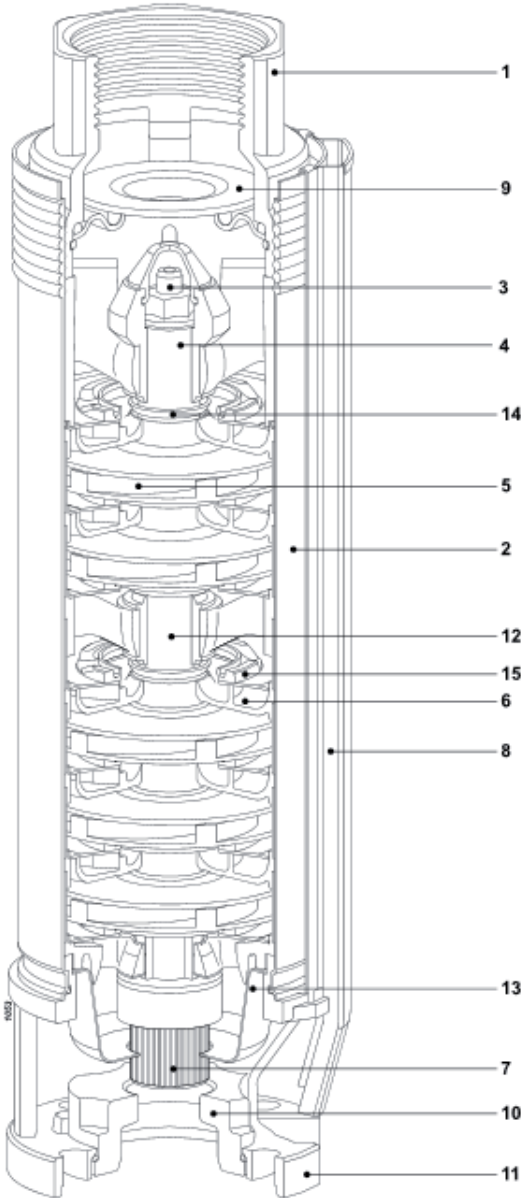

Pos.	Parts	Materials	Nomenclature	Matériaux	Nomenclatura	Materiale
1	Valve body	Stainless steel	Corps du clapet	Acier inox	Corpo valvola	Acciaio inox
2	Casing	Stainless steel	Chemise	Acier inox	Mantello	Acciaio inox
3	Shaft	Stainless steel	Arbre	Acier inox	Albero	Acciaio inox
4 (12)	Shaft sleeve	Aluminium oxide	Entretoise d'arbre	Alumine	Bussola albero	Allumina
5	Impeller	Technopolymer	Roue	Polymère technique	Girante	Tecnopolimero
6	Diffuser	Technopolymer	Diffuseur	Polymère technique	Diffusore	Tecnopolimero
7	Box coupling	Stainless steel	Accouplement a manchon	Acier inox	Manicotto di trasmissione	Acciaio inox
8	Cable guard	Stainless steel	Goutier protectif	Acier inox	Tegolo di protezione cavi	Acciaio inox
9	Conical valve	Stainless steel	Soupape du clapet	Acier inox	Clapet	Acciaio inox
9	Conical valve (E4XPD)	Technopolymer	Soupape du clapet (E4XPD)	Polymère technique	Clapet (E4XPD)	Tecnopolimero
10	Defender®	-	Defender®	-	Defender®	-
11	Suction cover	Stainless steel	Pièce d'aspiration	Acier inox	Supporto aspirazione	Acciaio inox
13	Strainer	Stainless steel	Crepine	Acier inox	Succheruola	Acciaio inox
14	Sand guard	Stainless steel	Para-sable	Acier inox	Parasabbia	Acciaio inox
15	Intermediate plate	Stainless steel/rubber	Disque intermediaire	Acier inox/caoutchouc	Disco intermedio	Acciaio inox/gomma

Bolts and nuts in stainless steel.

Visserie en acier inox

Bulloneria in acciaio inox

Pump construction and materials
 Construction de la pompe et matériaux
 Costruzione pompa e materiali

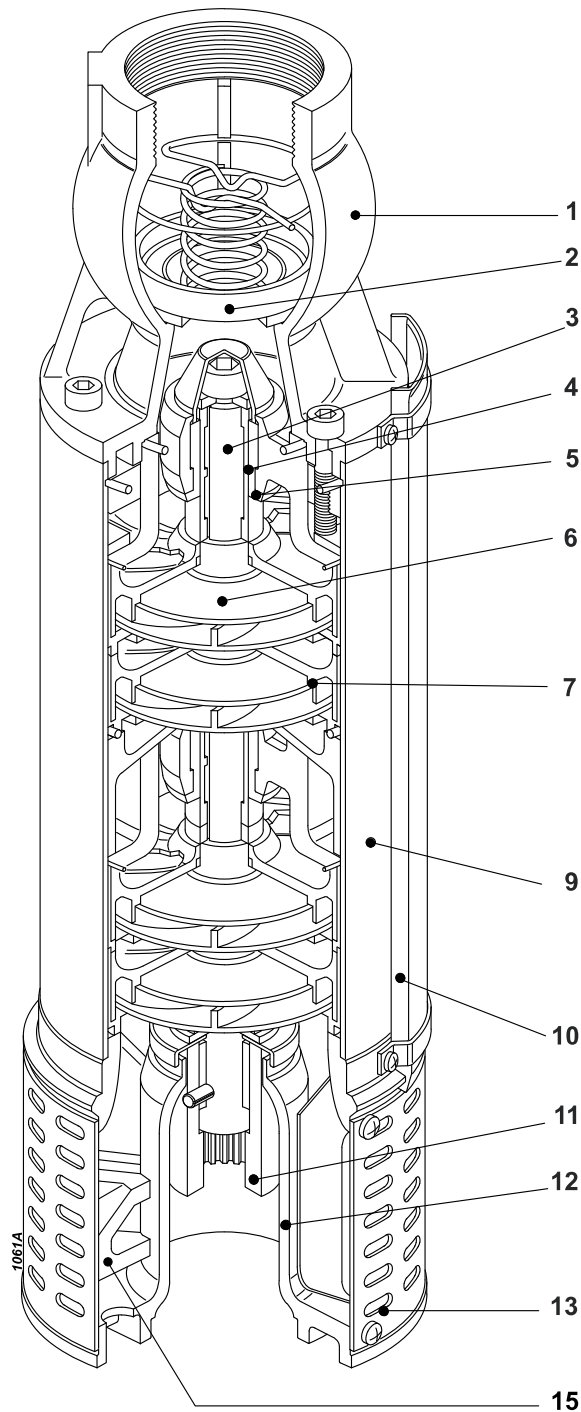

Pos.	Parts	Materials	Nomenclature	Matériaux	Nomenclatura	Materiale
1	Valve casing	Stainless steel	Corps du clapet	Acier inox	Corpo valvola	Acciaio inox
2	Conical valve	Stainless steel	Soupape du clapet	Acier inox	Clapet	Acciaio inox
3	Pump shaft	Stainless steel	Arbre de pompe	Acier inox	Albero	Acciaio inox
4	Shaft sleeve	Stainless steel	Entretoise d'arbre	Acier inox	Bussola albero	Acciaio inox
5	Shaft bearing bush	Rubber	Coussinet arbre pompe	Caoutchouc	Cuscinetto albero	Gomma
6	Impeller	Technopolymer	Roue	Polymère technique	Girante	Tecnopolimero
7	Diffuser	Technopolymer	Diffuseur	Polymère technique	Diffusore	Tecnopolimero
9	Stage casing	Stainless steel	Corps d'etage	Acier inox	Mantello	Acciaio inox
10	Cable guard	Stainless steel	Gouttière de protection	Acier inox	Tegolo protezione cavi	Acciaio inox
11	Coupling	Stainless steel	Accouplement rigide	Acier inox	Giunto rigido	Acciaio inox
12	Suction casing	Stainless steel	Pièce d'aspiration	Acier inox	Supporto aspirazione	Acciaio inox
13	Strainer	Stainless steel	Crepine	Acier inox	Succheruola	Acciaio inox
15	Defender®	-	Defender®	-	Defender®	-

Bolts and nuts in stainless steel

Visserie en acier inox

Bulloneria in acciaio inox

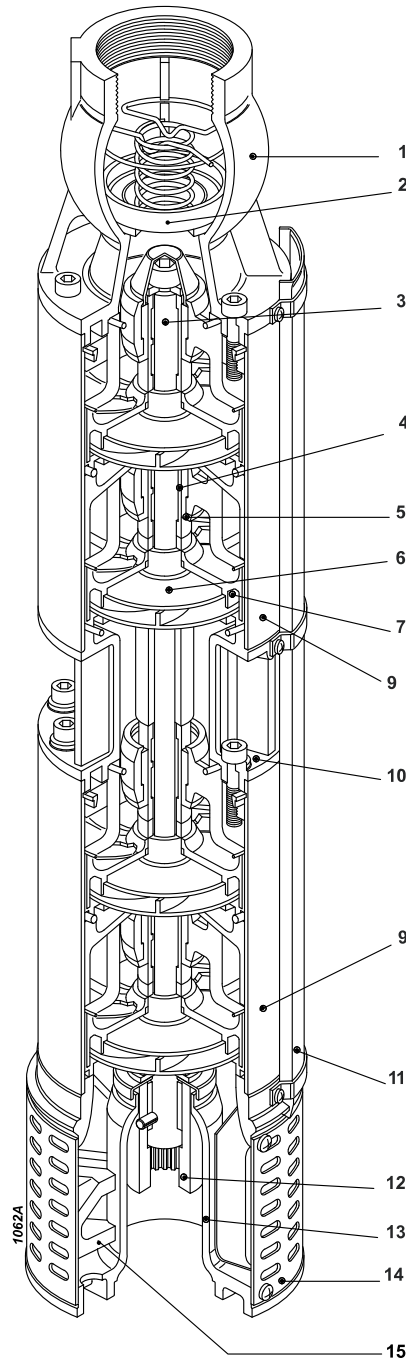

Pos.	Parts	Materials	Nomenclature	Matériaux	Nomenclatura	Materiale
1	Valve casing	Stainless steel	Corps du clapet	Acier inox	Corpo valvola	Acciaio inox
2	Conical valve	Stainless steel	Clapet	Acier inox	Clapet	Acciaio inox
3	Pump shaft	Stainless steel	Arbre de pompe	Acier inox	Albero	Acciaio inox
4	Shaft sleeve	Stainless steel	Entretoise d'arbre	Acier inox	Bussola albero	Acciaio inox
5	Shaft bearing bush	Rubber	Coussinet arbre pompe	Caoutchouc	Cuscinetto albero	Gomma
6	Impeller	Technopolymer	Roue	Polymère technique	Girante	Tecnopolimero
7	Diffuser	Technopolymer	Diffuseur	Polymère technique	Diffusore	Tecnopolimero
9	Stage casing	Stainless steel	Corps d'Etage	Acier inox	Mantello	Acciaio inox
10	Intermediate bearing	Stainless steel	Palier intermediaire	Acier inox	Supporto intermedio	Acciaio inox
11	Cable guard	Stainless steel	Gouttière de protection	Acier inox	Tegolo protezione cavi	Acciaio inox
12	Coupling	Stainless steel	Accouplement rigide	Acier inox	Giunto rigido	Acciaio inox
13	Suction cover	Stainless steel	Pièce d'aspiration	Acier inox	Supporto aspirazione	Acciaio inox
14	Strainer	Stainless steel	Crepine	Acier inox	Succheruola	Acciaio inox
15	Defender®	-	Defender®	-	Defender®	-

Bolts and nuts in stainless steel.

Visserie en acier inox

Bulloneria in acciaio inox

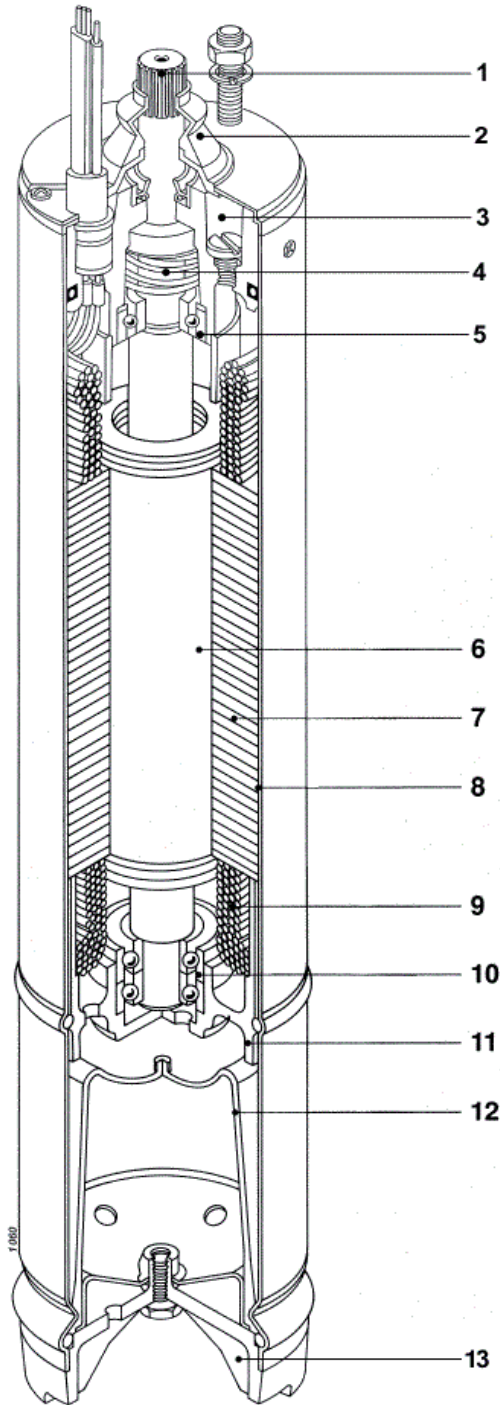

Pos.	Parts	Materials	Nomenclature	Matériaux	Nomenclatura	Materiale
1	Shaft	Stainless steel	Arbre	Acier inox	Albero	Acciaio inox
2	Sand guard	Rubber	para-sable	Caoutchouc	Parasabbia	Gomma
3	Upper bracket	Cast iron	Support supérieur	Fonte grise	Supporto superiore	Ghisa grigia
4	Mechanical seal	Ceramic/graphite	Garniture mécanique	Céramique/graphite	Tenuta meccanica	Ceramica/grafite
5	Upper ball bearing	Steel	Roulement supérieur	Acier	Cuscinetto superiore	Acciaio
6	Rotor	Electrical steel	Rotor	Tôle magnétique	Rotore	Lamierino magnetico
7	Stator	Electrical steel	Stator	Tôle magnétique	Statore	Lamierino magnetico
8	Stator shell	Stainless steel	Chemise de stator	Acier inox	Camicia statore	Acciaio inox
9	Winding	Copper	Bobinage	Cuivre	Avvolgimento	Rame
10	Lower ball bearing	Steel	Roulement inférieur	Acier	Cuscinetto inferiore	Acciaio
11	Lower bracket	Aluminium	Support inférieur	Aluminium	Supporto inferiore	Alluminio
12	Diaphragm	Rubber	Membrane	Caoutchouc	Membrana	Gomma
13	Diaphragm cover (MC..405-41)	Stainless steel	Couvercle de membrane (MC..405-41)	Acier inox	Coperchio membrana (MC..405-41)	Acciaio inox
13	Diaphragm cover (MC..415-410)	Technopolymer	Couvercle de membrane (MC..415-410)	Polymère technique	Coperchio membrana (MC..415-410)	Tecnopolimero

Bolts and nuts in stainless steel.

Visserie en acier inox

Bulloneria in acciaio inox

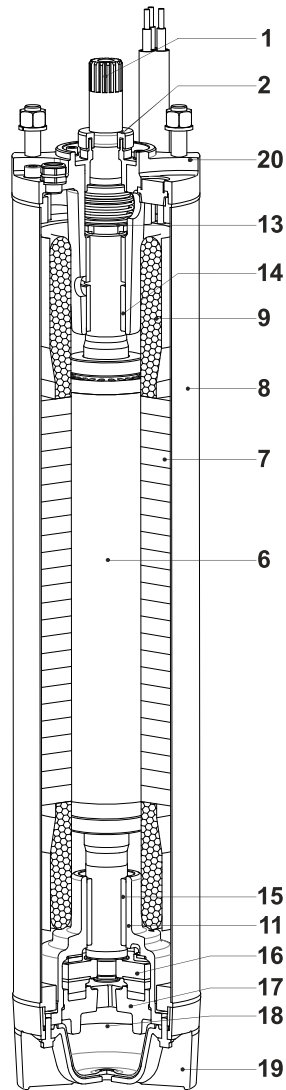

Pos.	Parts	Materials	Nomenclature	Matériaux	Nomenclatura	Materiale
1	Shaft	Stainless steel	Arbre	Acier inox	Albero	Acciaio inox
2	Sand guard	Rubber	para-sable	Caoutchouc	Parasabbia	Gomma
6	Rotor	Electrical steel	Rotor	Tôle magnétique	Rotore	Lamierino magnetico
7	Stator	Electrical steel	Stator	Tôle magnétique	Statore	Lamierino magnetico
8	Stator shell	Stainless steel	Chemise de stator	Acier inox	Camicia statore	Acciaio inox
9	Winding	HT wire	Bobinage	Fil HT	Avvolgimento	Filo HT
11	Lower bracket	Cast iron	Support inférieur	Fonte grise	Supporto inferiore	Ghisa grigia
13	Mechanical seal	Ceramic/graphite	Garniture mécanique	Céramique/graphite	Tenuta meccanica	Ceramica/grafite
14-15	Bearing	HT Composite	Coussinett	HT Composite	Cuscinetto	Composito HT
16	Thrust-bearing	Stainless steel/ Synthetic compound	Butée	Acier inox/Composé synthétique	Reggispinta	Acciaio inox/ Composto sintetico
17	Thrust-bearing foot slip	Cast iron	Support butée	Fonte grise	Supporto reggispinta	Ghisa grigia
18	Diaphragm	Rubber + nylon	Membrane	Caoutchouc + nylon	Membrana	Gomma + nylon
19	Diaphragm cover	Technopolymer	Couvercle de membrane	Polymère technique	Coperchio membrana	Tecnopolimero
20	Connecting flange	Cast iron	Support intermédiaire	Fonte grise	Elemento di raccordo	Ghisa grigia

Bolts and nuts in stainless steel.

Visserie en acier inox

Bulloneria in acciaio inox

Motor construction and materials
Construction du moteur et matériaux
Costruzione motore e materiali

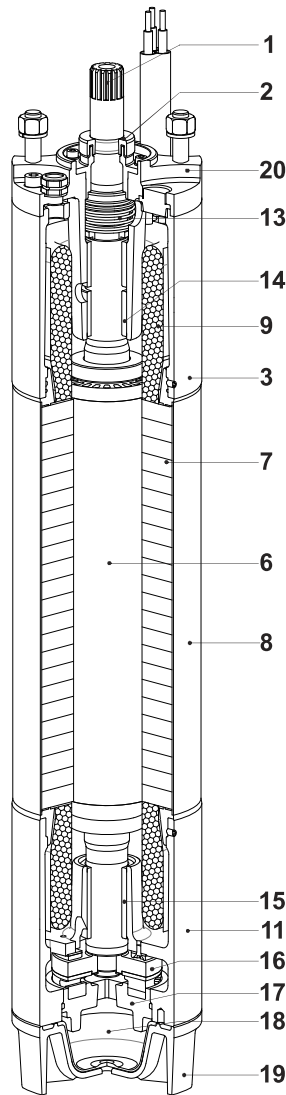

Pos.	Parts	Materials	Nomenclature	Matériaux	Nomenclatura	Materiale
1	Shaft	Stainless steel	Arbre	Acier inox	Albero	Acciaio inox
2	Sand guard	Rubber	para-sable	Caoutchouc	Parasabbia	Gomma
3	Connecting flange	Cast iron	Support intermediaire	Fonte grise	Elemento di raccordo	Ghisa grigia
6	Rotor	Electrical steel	Rotor	Tôle magnétique	Rotore	Lamierino magnetico
7	Stator	Electrical steel	Stator	Tôle magnétique	Statore	Lamierino magnetico
8	Stator shell	Stainless steel	Chemise de stator	Acier inox	Camicia statore	Acciaio inox
9	Winding	HT wire	Bobinage	Fil HT	Avvolgimento	Filo HT
11	Lower bracket	Cast iron	Support inférieur	Fonte grise	Supporto inferiore	Ghisa grigia
13	Mechanical seal	Silicon carbide/ silicon carbide	Garniture mécanique	Carbure de silicium/ carbure de silicium	Tenuta meccanica	Carburo di silicio/ Carburo di silicio
14-15	Bearing	HT Composite	Couissinett	HT Composite	Cuscinetto	Composito HT
16	Thrust-bearing	Stainless steel/ Synthetic compound	Butée	Acier inox/Composé synthétique	Reggispinta	Acciaio inox/ Composito sintetico
17	Thrust-bearing foot slip	Cast iron	Support butée	Fonte grise	Supporto reggispinta	Ghisa grigia
18	Diaphragm	Rubber	Membrane	Caoutchouc	Membrana	Gomma
19	Diaphragm cover	Cast iron	Couvercle de membrane	Fonte grise	Coperchio membrana	Ghisa grigia
20	Upper bracket	Cast iron	Support supérieur	Fonte grise	Supporto superiore	Ghisa grigia

Bolts and nuts in stainless steel.

Visserie en acier inox

Bulloneria in acciaio inox

General notes about the wet end
Remarques générales partie hydraulique
 Note generali parte idraulica

- a) The normal construction version of **Desert** line submersible electric pumps is designed for lifting water chemically and mechanically non-aggressive for the components.
- b) Maximum content of solids, the same hardness and granulometry of silt: E4XED - E6XD 300 g/m³
- c) Maximum operating time when the outlet is closed and the pump is submersed: 3 min.
- d) The hydraulic performance characteristics were measured with 400 V powered motors, cold water (15°C) and atmospheric pressure (1 bar). They are guaranteed as conforming to standard UNI/ISO 9906 Grade 3B.
 The hydraulic characteristics of units coupled to MAC 6...-2B 6" motors are guaranteed as conforming to standard UNI/ISO 9906 Grade 2B.
- The catalogue given data refer to liquids with a density of 1 kg/dm³ and kinematic viscosity of not more than 1 mm²/s, are comprehensive of friction losses in the check valves.
- e) UPON REQUEST
 - Pumps can be tested according to UNI/ISO 9906 Grade 2B.
 - Special executions can be supplied with:
 • for horizontal installation, if not usually foreseen.
- f) Extra performance:
 Pumps for specific applications with a high percentage of solids and sand:
 E4XPD60 - E6XPD52 450 g/m
- a) *Les électropompes immergées ligne Desert, dans la version à fabrication standard, sont adaptées au relevage d'eau qui n'est pas chimiquement et mécaniquement agressive pour les matériaux des composants.*
- b) *Contenu maximum des substances solides de la dureté et la granulométrie du limon: E4XED - E6XD 300 g/m³*
- c) *Temps maximum de fonctionnement, à vanne fermée et pompe submergée: 3 min.*
- d) *Les caractéristiques hydrauliques de fonctionnement ont été mesurées avec des moteurs à 400 V, avec de l'eau froide (15° C) à une pression atmosphérique (1bar). Elles sont garanties conformes à la norme UNI/ISO 9906 Niveau 3B. Pour les groupes accouplés à des moteurs 6" MAC 6...-2B les caractéristiques hydrauliques sont garanties conformes à la norme UNI/ISO 9906 Niveau 2B.*
- Les données du catalogue se réfèrent à un liquide pompé de densité de 1 kg/dm³ et avec une viscosité cinématique non supérieure à 1 mm²/s. Elles comprennent les pertes de charge dans les clapets de retenue.*
- e) **SUR DEMANDE**
 - *Les pompes peuvent être testées selon les normes UNI/ISO 9906 Niveau 2B.*
 - *Nous pouvons fournir des exécutions spéciales:*
 • *pour installation horizontale si pas normalement prévue.*
- f) *Extra performance: Pompes pour applications spécifiques à haute teneur en solides et sable: E4XPD60 - E6XPD52 450 g/m³.*
- a) **Le elettropompe sommersa linea Desert, nella normale versione costruttiva, sono adatte al sollevamento di acqua chimicamente e meccanicamente non aggressiva per i materiali dei componenti.**
- b) **Contenuto massimo di sostanze solide della durezza e granulometria del limo: E4XED - E6XD 300 g/m³**
- c) **Tempo massimo di funzionamento a bocca chiusa e pompa sommersa: 3 min.**
- d) **Le caratteristiche idrauliche di funzionamento sono state rilevate con motori alimentati a 400 V, con acqua fredda (15° C) alla pressione atmosferica (1bar). Vengono garantite secondo la norma UNI/ISO 9906 Grado 3B. Per i gruppi accoppiati a motori 6" MAC 6...-2B le caratteristiche idrauliche vengono garantite secondo la norma UNI/ISO 9906 Grado 2B.**
- I dati di catalogo si riferiscono a liquidi con densità di 1 kg/dm³ e con viscosità cinematica non superiore a 1 mm²/s, e sono comprensivi delle perdite di carico nelle valvole di ritegno.**
- e) **SU RICHIESTA**
 - **Possono essere collaudate secondo le norme UNI/ISO 9906 Grado 2B.**
 - **Possono essere fornite esecuzioni speciali:**
 • **per installazione in orizzontale, quando non già prevista.**
- f) **Extra performance:**
Pompe per applicazioni specifiche ad alto contenuto di solidi e sabbia: E4XPD60 - E6XPD52 450 g/m³

Motor general remarks
Notes générales moteur
Note generali motore

- | | | |
|---|---|--|
| <p>a) Maximum submersion: 150 m
Speed of the water outside the jacket of the motor higher:
0,08 m/s for motors 4"
0,1 m/s for motors MAC...A (5-15 cv)
0,2 m/s for motors MAC...A (17-40 cv)
0,1 m/s for motors MAC...B (50 cv)
0,3 m/s for motors MAC...B (60 cv)</p> <p>Max temperature liquid
MC4.. = 35°C
MAC6...A = 30°C (5-20 cv)
MAC6...A = 25°C (25-40 cv)
MAC6...B = 40°C (5-60 cv)</p> <p>b) STANDARD VERSION - THREE-PHASE/50 Hz supply voltage</p> <p>Direct starting:
MC-MAC...-8;
400 V for all power outputs
All the motors are fit for operation with an inverter, but in compliance with the following instructions:
a filter is to be provided between the motor and the inverter to keep the voltage gradient (contact the sales network).</p> <p>MAC6..
MAC6..-2A
Submersible motor with high efficiency. (standard motor)</p> <p>c) VERSION ON REQUEST - THREE-PHASE/50 Hz supply voltage
4" MC...-6V 230V fino a 7,5 kW
6": MAC6..-2B / -2C
230 V up to 30 kW,
MAC...-7 230/400 V up to 37 kW
MAC...-9 400/700 V up to 45 kW</p> <p>In addition, motors can be supplied:
- for other voltages and frequencies
- single-phase motors
MC..M.-1 220/230 V up to 2,2 kW
MC..M.-2 230/240 V up to 2,2 kW
- with special materials for aggressive water</p> <p>MAC6..
MAC6..-2B / -2C
Submersible motor specified for high temperature or for huge sand's content. For any further information please do not hesitate to contact our service network.</p> <p>d) Permissible variations on the stated supply voltages without brackets:
4";6": (220 V), 230 V, (240 V) ± 10%
(380 V), 400 V, (415 V) ± 10%
single-phase motors 4 " : ± 5%
4"-6": for other voltages and frequencies ± 5%</p> <p>Tolerances on the operating data: according to the International Standards IEC 34-1.
Thermal probes on request with 4 m of cable outlet.</p> | <p>a) Immersion maximum : 150 m
Vitesse de l'eau à l'extérieur de la chemise du moteur supérieure à :
0,08 m/s pour moteurs 4"
0,1 m/s pour moteurs MAC...A (5-15 cv)
0,2 m/s pour moteurs MAC...A (17-40 cv)
0,1 m/s pour moteurs MAC...B (50 cv)
0,3 m/s pour moteurs MAC...B (60 cv)</p> <p>Température Max liquide
MC4.. = 35°C
MAC6...A = 30°C (5-20 cv)
MAC6...A = 25°C (25-40 cv)
MAC6...B = 40°C (5-60 cv)</p> <p>b) EXECUTION STANDARD - Tension d'alimentation TRIPHASEE/50 Hz</p> <p>Démarrage direct :
MC-MAC...-8;
400 V pour toutes les puissances
Tous les moteurs sont adaptés au fonctionnement à variateur de fréquence mais d'après les prescriptions suivantes:
un filtre entre le moteur et le variateur de fréquence est à prévoir pour maintenir le gradient de tension (contacter le réseau de vente).</p> <p>MAC6..
MAC6..-2A
Moteur submersible avec prestations élevées. (moteur standard)</p> <p>c) EXECUTION SUR DEMANDE - Tension d'alimentation TRIPHASEE/50 Hz
4": MC...-6V 230V fino a 7,5 kW
6": MAC6..-2B / -2C
230 V jusqu'à 30 kW,
MAC...-7 230/400 V jusqu'à 37 kW
MAC...-9 400/700 V jusqu'à 45 kW</p> <p>En outre, des moteurs peuvent être fournis :
- pour tensions et fréquences différentes
- monophasés
MC..M.-1 220/230 V jusqu'à 2,2 kW
MC..M.-2 230/240 V jusqu'à 2,2 kW
- avec matériaux spéciaux pour eau agressive.</p> <p>MAC6..
MAC6..-2B / -2C
Moteur submersible spécifique pour utilisation à haute température ou à haut contenu de sable.
pour toute information complémentaire, n'hésitez pas à contacter notre réseau de vente.</p> <p>d) Variations admises sur les tensions d'alimentation indiquées sans parenthèses :
4";6" : (220 V), 230 V, (240 V) ± 10%
(380 V), 400 V, (415 V) ± 10%
monophasés 4" : ± 5%
4"-6 " : pour tensions et fréquences différentes ± 5%</p> <p>Tolérances sur les caractéristiques de fonctionnement : selon les normes internationales IEC 34-1.
Sondes thermiques sur demande avec 4 m de sortie de câble.</p> | <p>a) Battente massimo: 150 m
Velocità dell'acqua all'esterno della camicia del motore superiore:
0,08 m/s per motori 4"
0,1 m/s per motori MAC...A (5-15 cv)
0,2 m/s per motori MAC...A (17-40 cv)
0,1 m/s per motori MAC...B (50 cv)
0,3 m/s per motori MAC...B (60 cv)</p> <p>Temperatura Max liquido
MC4.. = 35°C
MAC6...A = 30°C (5-20 cv)
MAC6...A = 25°C (25-40 cv)
MAC6...B = 40°C (5-60 cv)</p> <p>b) ESECUZIONE STANDARD - Tensione di alimentazione TRIFASE/50 Hz</p> <p>Avviamento diretto:
MC-MAC...-8;
400V per tutte le potenze
Tutti i motori sono idonei al funzionamento con inverter ma secondo le seguenti prescrizioni:
tra inverter e motore aggiungere un filtro per attenuare il gradiente di tensione (contattare la rete di vendita)</p> <p>MAC6..
MAC6..-2A
Motore sommerso ad alte prestazioni. (motore standard)</p> <p>c) ESECUZIONE DISPONIBILI - Tensione di alimentazione TRIFASE/50 Hz
4": MC...-6V 230V fino a 7,5 kW
6": MAC6..-2B / -2C
230 V fino a 30 kW,
MAC...-7 230/400 V fino a 37 kW
MAC...-9 400/700 V fino a 45 kW</p> <p>Possono inoltre essere forniti motori:
- per tensioni e frequenze diverse
- monofase
MC..M.-1 220/230 V fino a 2,2 kW
MC..M.-2 230/240 V fino a 2,2 kW
- con materiali speciali per acqua aggressiva.</p> <p>MAC6..
MAC6..-2B / -2C
Motore sommerso per utilizzo ad alte temperature o alti contenuti di sabbia. Per ulteriori informazioni contattare la nostra rete di vendita</p> <p>d) Variazioni ammesse sulle tensioni di alimentazione indicate senza parentesi:
4"; 6": (220 V), 230 V, (240 V) ± 10%
(380 V), 400 V, (415 V) ± 10%
monofase 4" ± 5%
4"-6": per tensioni/frequenze diverse ± 5%</p> <p>Tolleranze sulle caratteristiche di funzionamento: secondo le Norme Internazionali IEC 34-1.
Sonde termiche su richiesta con 4 m di cavo uscente.</p> |
|---|---|--|

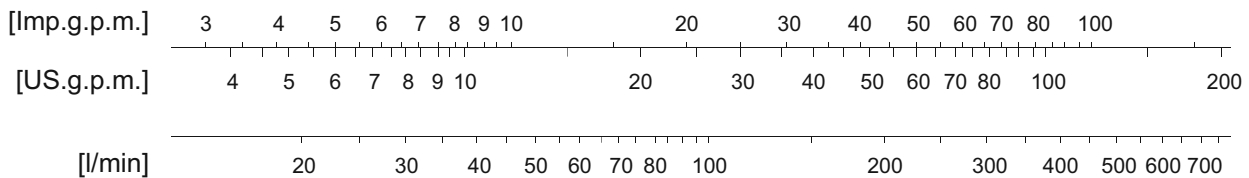
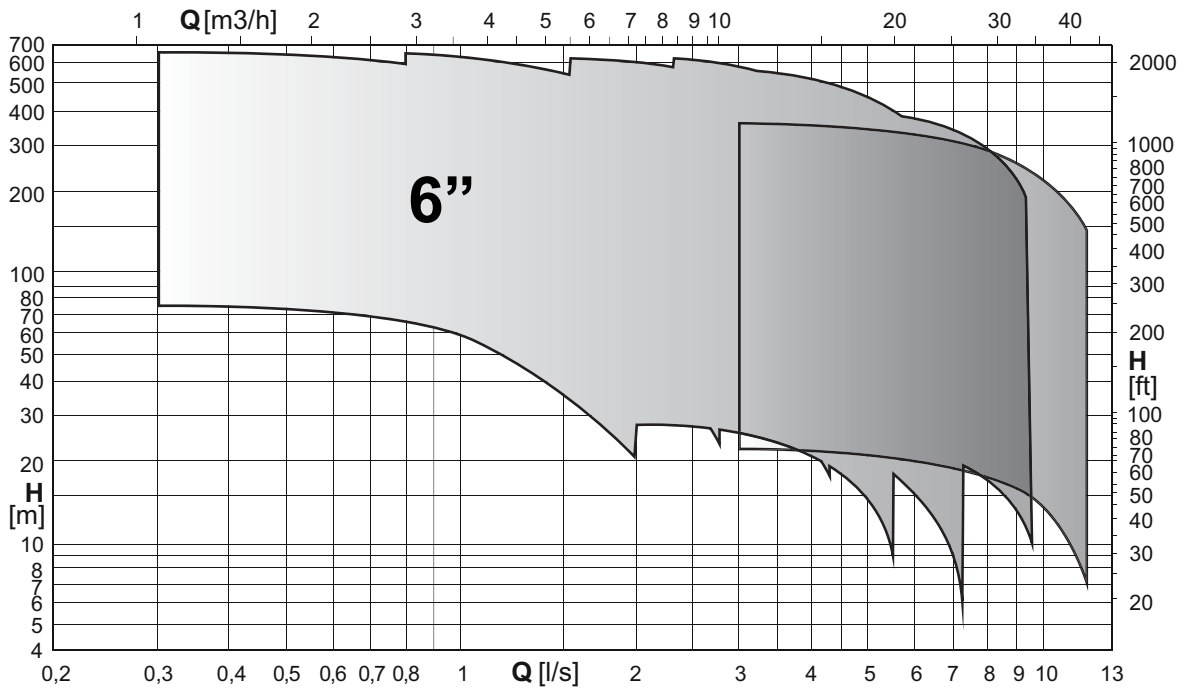
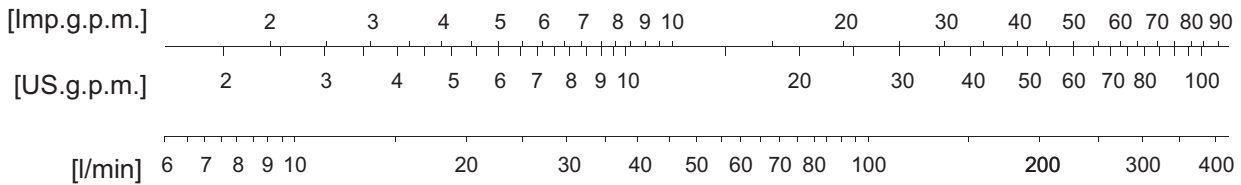
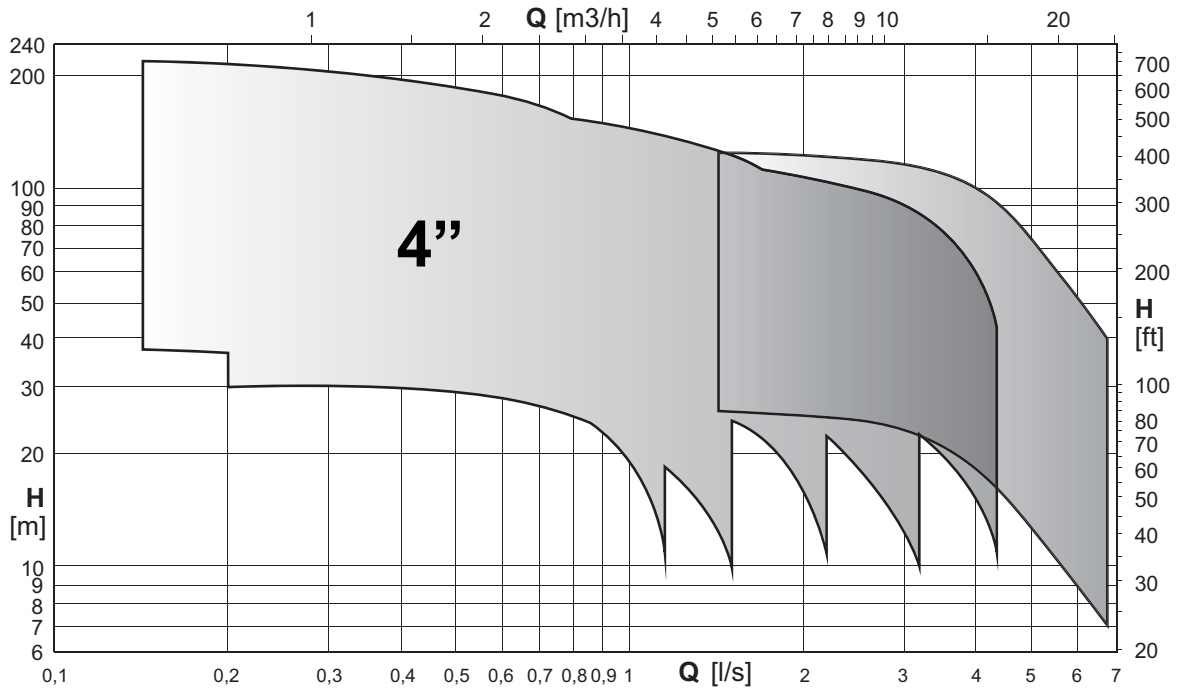

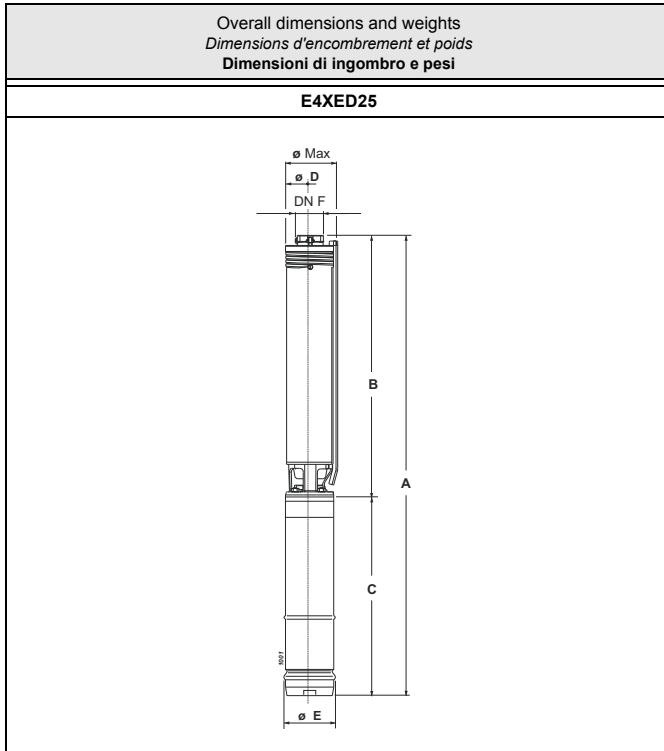

Type Type Tipo	Ø max [mm]	Weight Poids Peso [kg]	A	B	C	D	E	F
			[mm]					
E4XED25/6+MC405	98	10,6	619,5	299,5	320	93	96	G1 1/4
E4XED25/9+MC4075	98	11,7	699,5	359,5	340	93	96	G1 1/4
E4XED25/12+MC41	98	13	759,5	419,5	340	93	96	G1 1/4
E4XED25/18+MCH415	98	15,2	889,5	539,5	350	93	96	G1 1/4
E4XED25/25+MCH42	98	17,3	1104	707	397	93	96	G1 1/4
E4XED25/31+MCK43	98	19,9	1264	827	437	93	96	G1 1/4
E4XED25/37+MCK43	98	21	1384	947	437	93	96	G1 1/4

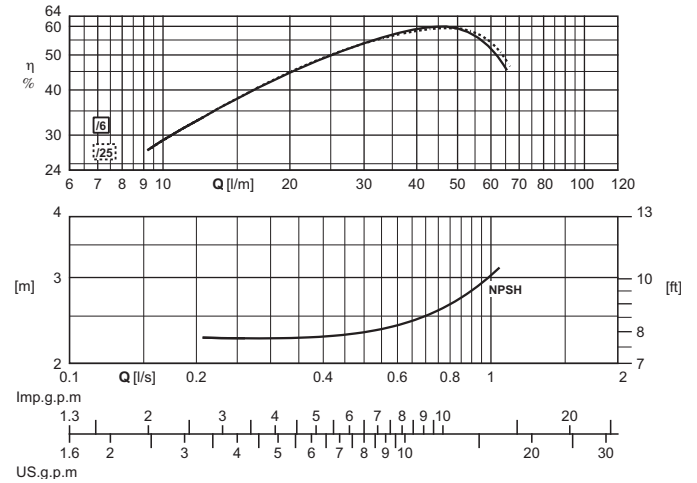
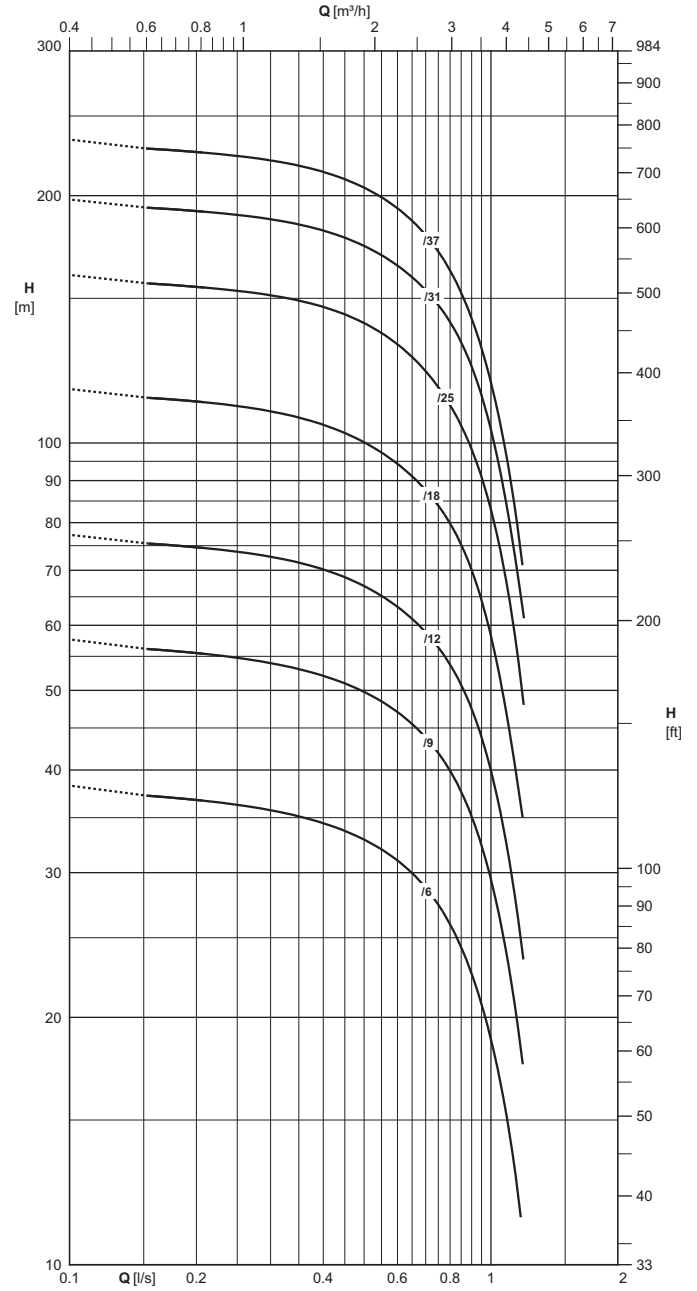

The hydraulic performance characteristics are guaranteed as conforming to standard UNI/ISO 9906 Grade 3B.

Les caractéristiques hydrauliques de fonctionnement sont garanties conformes à la norme UNI/ISO 9906 Niveau 3B.

Le caratteristiche di funzionamento vengono garantite secondo la norma: UNI/ISO 9906 Grado 3B.

Electric pump type Electropompe type Elettropompa tipo	Motor power Puis. moteur Potenza motore		Horizontal installation Installation horizontale Installazione orizzontale	Check valve \varnothing Clapet de retenue \varnothing Valvola di ritegno \varnothing	Capacity Debit Portata											
					[l/s]	0	0,2	0,3	0,4	0,5	0,6	0,7	0,8	0,9	1	1,2
	[l/min]	0			12	18	24	30	36	42	48	54	60	72		
	[m ³ /h]	0			0,7	1,1	1,4	1,8	2,2	2,5	2,9	3,2	3,6	4,3		
[kW]	[HP]	Head Hauteur Prevalenza														
E4XED25/6+MC405	0,37	0,5	<input type="radio"/>	11/4" Gas	[m]	38,5	37	36	35	33,5	31,5	29	26	24	20,5	11,5
E4XED25/9+MC4075	0,55	0,8	<input type="radio"/>	11/4" Gas	[m]	58	56	55	53	50	47,5	44	42	37	31	17,5
E4XED25/12+MC41	0,75	1	<input type="radio"/>	11/4" Gas	[m]	77	75	73	71	67	63	59	56	50	42	23,5
E4XED25/18+MCH415	1,1	1,5	<input type="radio"/>	11/4" Gas	[m]	116	113	110	106	101	95	88	84	74	62	35
E4XED25/25+MCH42	1,5	2	<input type="radio"/>	11/4" Gas	[m]	160	156	153	148	141	132	122	116	103	87	48
E4XED25/31+MCK43	2,2	3	<input type="radio"/>	11/4" Gas	[m]	198	193	189	183	175	165	153	146	129	108	61
E4XED25/37+MCK43	2,2	3	<input type="radio"/>	11/4" Gas	[m]	234	228	223	216	206	194	179	171	150	126	71
NPSH					[m]	-	2,3	2,3	2,3	2,3	2,4	2,5	2,6	2,7	2,9	-
M.E.I. \geq 0.40																

Without conical valve

On request

Please contact our sales organisation

For motor performances specification see page "motor features"

Temperature monitoring device for submersed electric motors 4" + 6":
 see page "Accessories"

Sans soupape du clapet.

Sur demande

Contacter notre service commercial.

Pour caractéristiques techniques moteurs voir page "Caractéristiques des moteurs"

Appareillage de contrôle de la température des moteurs électriques
 immergés 4" + 6": voir page "Accessories"

Senza clapet valvola di ritegno

Su richiesta

Interpellare la sede o la rete di vendita

Per caratteristiche motori vedere pagina caratteristiche motori

Apparecchiatura di controllo temperatura motori elettrici
 sommersi 4" + 6": vedere pagina accessori

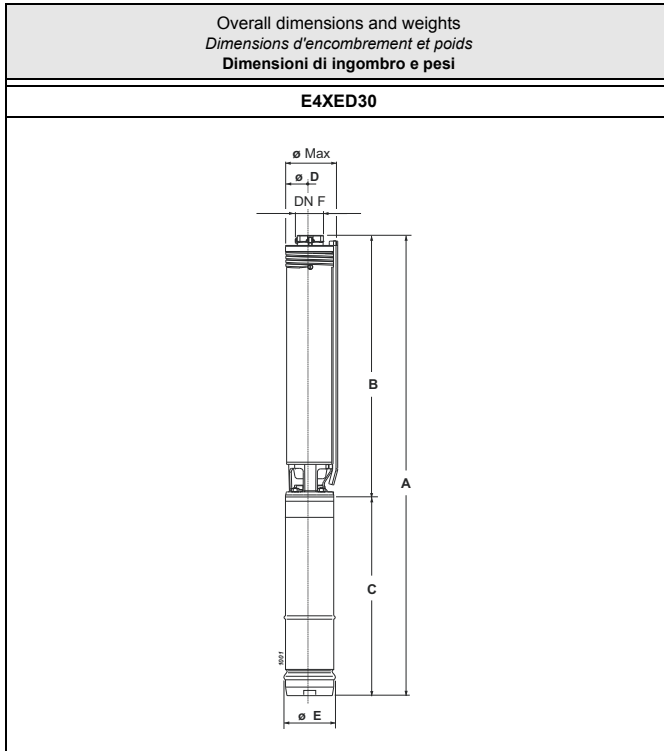

Type Type Tipo	Ø max	Weight Poids Peso	A	B	C	D	E	F
E4XED30/5+MC405	98	9,9	628,5	308,5	320	93	96	G1 1/4
E4XED30/8+MC4075	98	11,7	723,5	383,5	340	93	96	G1 1/4
E4XED30/11+MC41	98	12,9	798,5	458,5	340	93	96	G1 1/4
E4XED30/16+MCH415	98	15,2	933,5	583,5	350	93	96	G1 1/4
E4XED30/21+MCH42	98	17,2	1133	736	397	93	96	G1 1/4
E4XED30/32+MCK43	98	20,9	1448	1011	437	93	96	G1 1/4

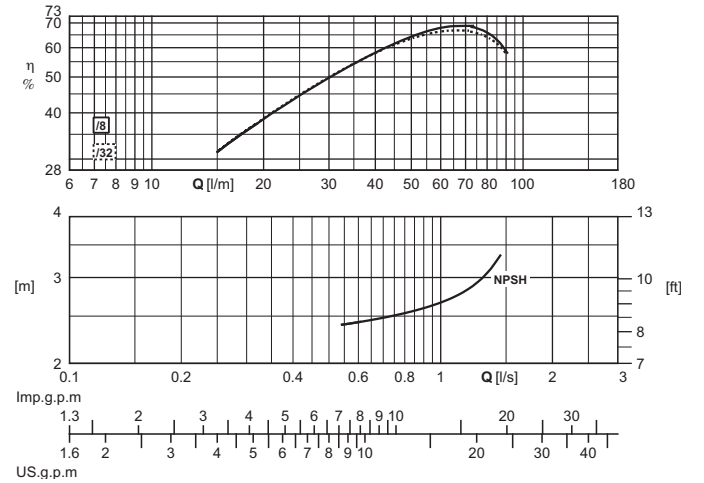
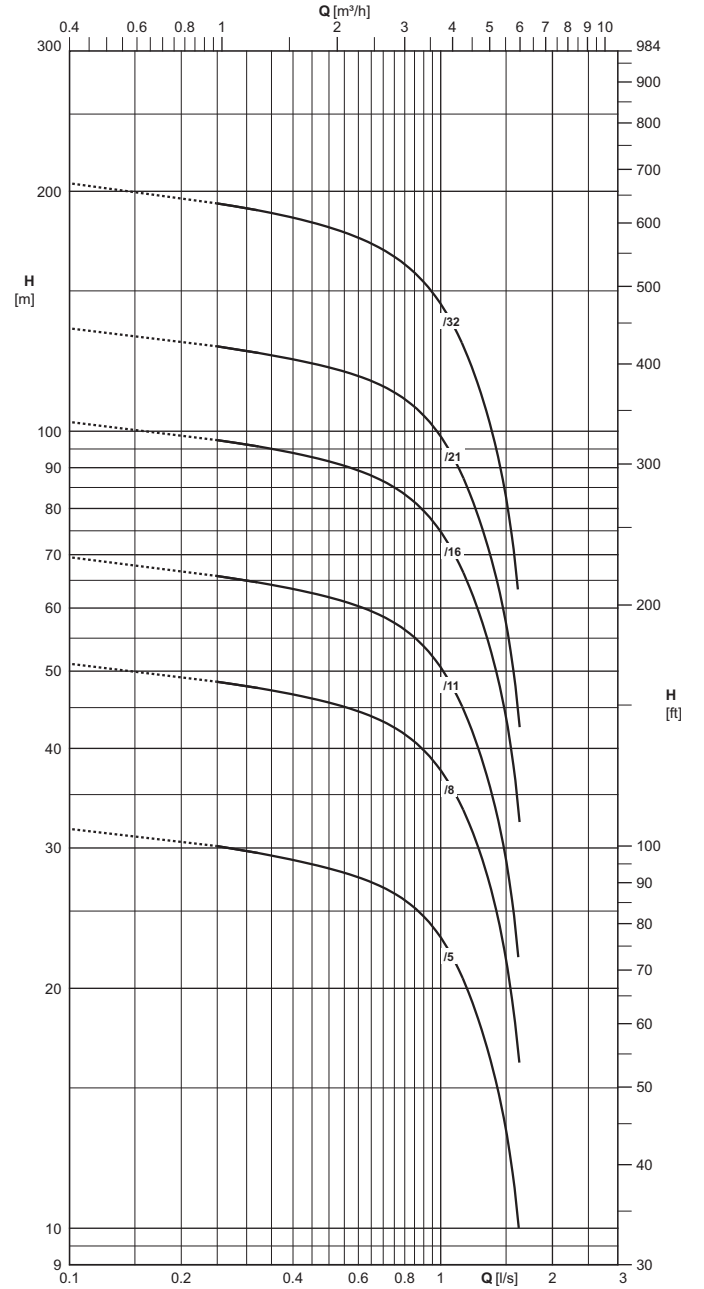

The hydraulic performance characteristics are guaranteed as conforming to standard UNI/ISO 9906 Grade 3B.

Les caractéristiques hydrauliques de fonctionnement sont garanties conformes à la norme UNI/ISO 9906 Niveau 3B.

Le caratteristiche di funzionamento vengono garantite secondo la norma: UNI/ISO 9906 Grado 3B.

Electric pump type Electropompe type Elettropompa tipo	Motor power Puisse. moteur Potenza motore		Horizontal installation Installation horizontale Installazione orizzontale	Check valve Ø Clapet de retenue Ø Valvola di ritegno Ø	Capacity Debit Portata												
					[l/s]	0	0,3	0,4	0,5	0,6	0,7	0,8	0,9	1	1,2	1,4	1,6
	[l/min]	0			18	24	30	36	42	48	54	60	72	84	96		
	[m³/h]	0			1,1	1,4	1,8	2,2	2,5	2,9	3,2	3,6	4,3	5	5,8		
[kW]	[HP]	Head Hauteur Prevalenza															
E4XED30/5+MC405	0,37	0,5	○	11/4" Gas	[m]	31,5	29,5	29	28,5	27,5	27	26,5	24,5	23,5	20	15,5	12
E4XED30/8+MC4075	0,55	0,8	○	11/4" Gas	[m]	51	47,5	47	46	44,5	43,5	42,5	39,5	38	32	25	19,5
E4XED30/11+MC41	0,75	1	○	11/4" Gas	[m]	69	64	63	62	60	59	57	54	52	43,5	34	22
E4XED30/16+MCH415	1,1	1,5	○	11/4" Gas	[m]	103	97	94	92	89	87	85	79	76	64	50	39
E4XED30/21+MCH42	1,5	2	○	11/4" Gas	[m]	134	128	123	121	117	114	111	104	100	84	65	51
E4XED30/32+MCK43	2,2	3	○	11/4" Gas	[m]	205	189	186	182	174	170	165	154	148	124	97	63
NPSH					[m]	-	-	-	2,4	2,4	2,5	2,5	2,6	2,6	2,8	3,2	-

M.E.I. ≥ 0.40

■ Without conical valve

□ On request

○ Please contact our sales organisation

For motor performances specification see page "motor features"

■ Sans soupape du clapet.

□ Sur demande

○ Contacter notre service commercial.

Pour caractéristiques techniques moteurs voir page "Caractéristiques des moteurs"

■ Senza clapet valvola di ritegno

□ Su richiesta

○ Interpellare la sede o la rete di vendita

Per caratteristiche motori vedere pagina caratteristiche motori

Temperature monitoring device for submersed electric motors 4" + 6": Appareillage de contrôle de la température des moteurs électriques immergés 4" + 6": voir page "Accessories"

Apparecchiatura di controllo temperatura motori elettrici sommersi 4" + 6": vedere pagina accessori

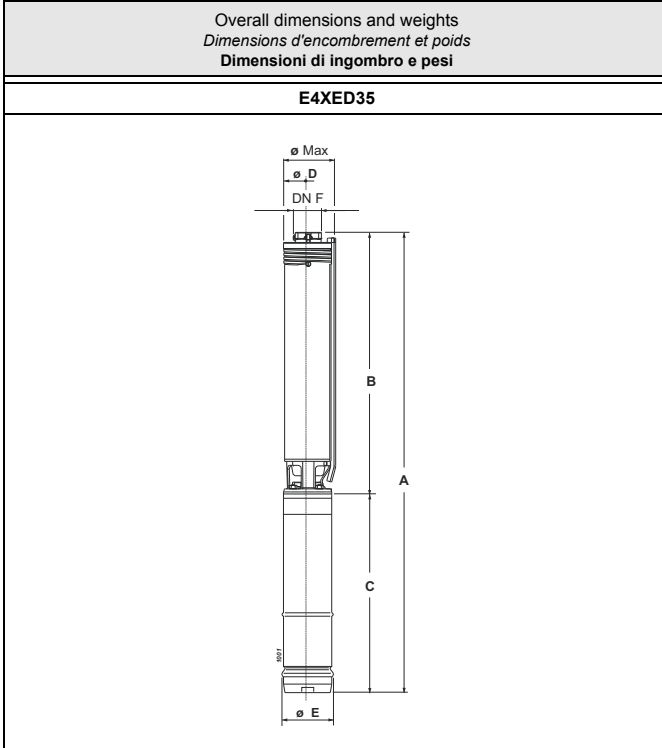

Type Type Tipo	ø max [mm]	Weight Poids Peso [kg]	A	B	C	D	E	F
			[mm]					
E4XED35/5+MC4075	98	11,3	669,5	329,5	340	93	96	G1 1/4
E4XED35/7+MC41	98	12,5	729,5	389,5	340	93	96	G1 1/4
E4XED35/10+MCH415	98	14,5	829,5	479,5	350	93	96	G1 1/4
E4XED35/14+MCH42	98	16	996,5	599,5	397	93	96	G1 1/4
E4XED35/20+MCH43	98	19,2	1216,5	779,5	437	93	96	G1 1/4
E4XED35/27+MCH44	98	23,2	1407,5	989,5	418	93	96	G1 1/4

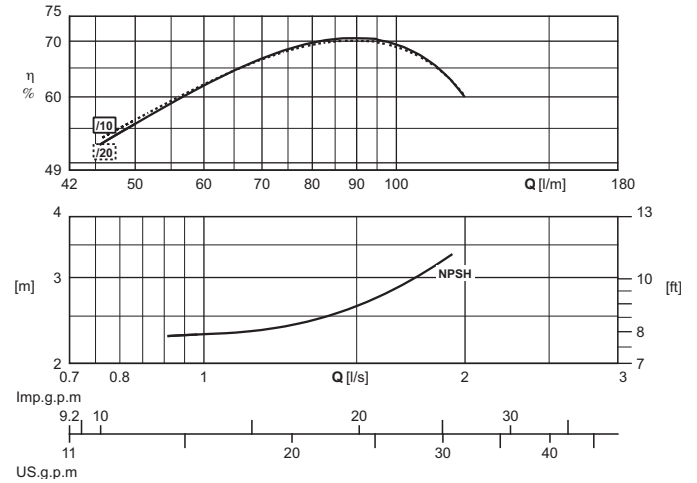
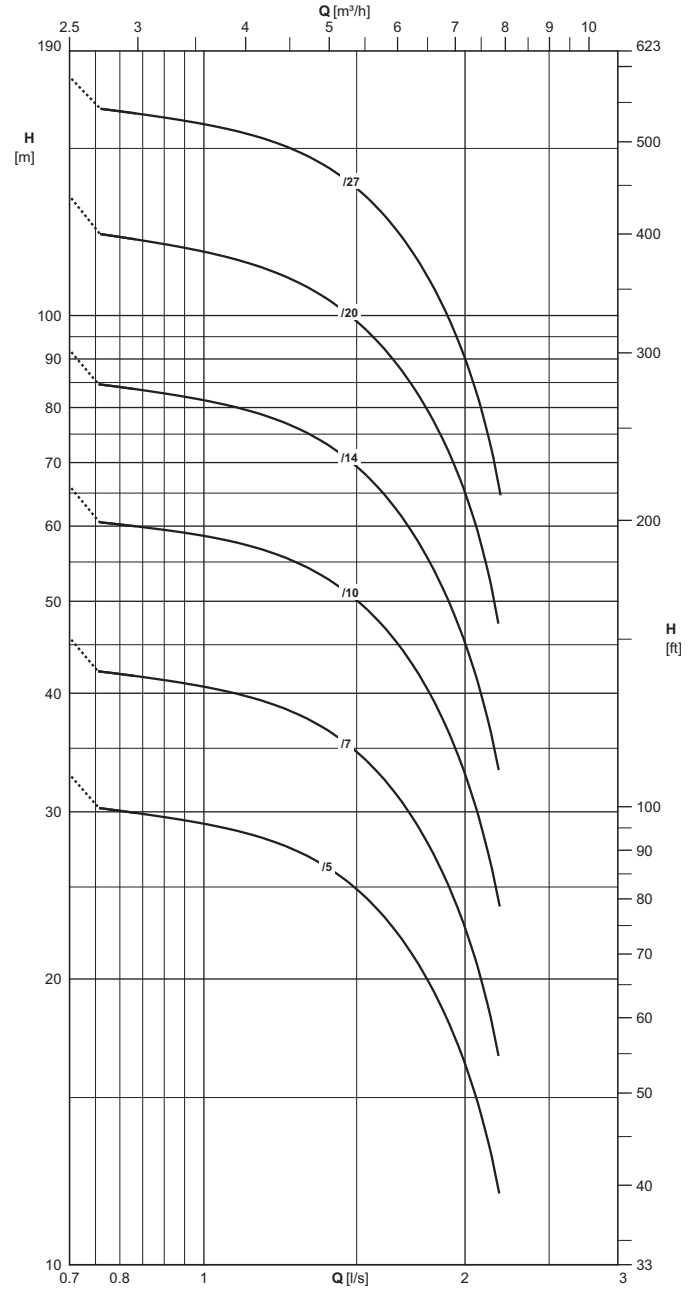

The hydraulic performance characteristics are guaranteed as conforming to standard UNI/ISO 9906 Grade 3B.

Les caractéristiques hydrauliques de fonctionnement sont garanties conformes à la norme UNI/ISO 9906 Niveau 3B.

Le caratteristiche di funzionamento vengono garantite secondo la norma: UNI/ISO 9906 Grado 3B.

Electric pump type Electropompe type Elettropompa tipo	Motor power Puisse. moteur Potenza motore		Horizontal installation Installation horizontale Installazione orizzontale	Check valve Ø Clapet de retenue Ø Valvola di ritegno Ø	Capacity Debit Portata										
					[l/s]	0	0,8	0,9	1	1,2	1,4	1,6	1,8	2	2,2
	[l/min]	0			48	54	60	72	84	96	108	120	132		
	[m³/h]	0			2,9	3,2	3,6	4,3	5	5,8	6,5	7,2	7,9		
[kW]	[HP]	Head Hauteur Prevalenza													
E4XED35/5+MC4075	0,55	0,8	○	11/4" Gas	[m]	33	30,5	29,5	29	28	26,5	23,5	20	17	12
E4XED35/7+MC41	0,75	1	○	11/4" Gas	[m]	46	42	41,5	41	39	37	33	28	24	16,5
E4XED35/10+MCH415	1,1	1,5	○	11/4" Gas	[m]	66	61	59	59	56	53	47,5	40	34,5	24
E4XED35/14+MCH42	1,5	2	○	11/4" Gas	[m]	92	84	83	82	78	74	66	55	47,5	33
E4XED35/20+MCH43	2,2	3	○	11/4" Gas	[m]	133	122	119	117	111	105	94	79	68	47,5
E4XED35/27+MCH44	3	4	○	11/4" Gas	[m]	178	165	161	159	152	144	129	109	93	65
NPSH					[m]	-	-	2,3	2,3	2,4	2,5	2,7	3,1	3,4	-
M.E.I. ≥ 0.40															

■ Without conical valve

□ On request

○ Please contact our sales organisation

For motor performances specification see page "motor features"

■ Sans soupape du clapet.

□ Sur demande

○ Contacter notre service commercial.

Pour caractéristiques techniques moteurs voir page "Caractéristiques des moteurs"

■ Senza clapet valvola di ritegno

□ Su richiesta

○ Interpellare la sede o la rete di vendita

Per caratteristiche motori vedere pagina caratteristiche motori

Temperature monitoring device for submersed electric motors 4" + 6": Appareillage de contrôle de la température des moteurs électriques immergés 4" + 6": voir page "Accessories"

Apparecchiatura di controllo temperatura motori elettrici sommersi 4" + 6": vedere pagina accessori

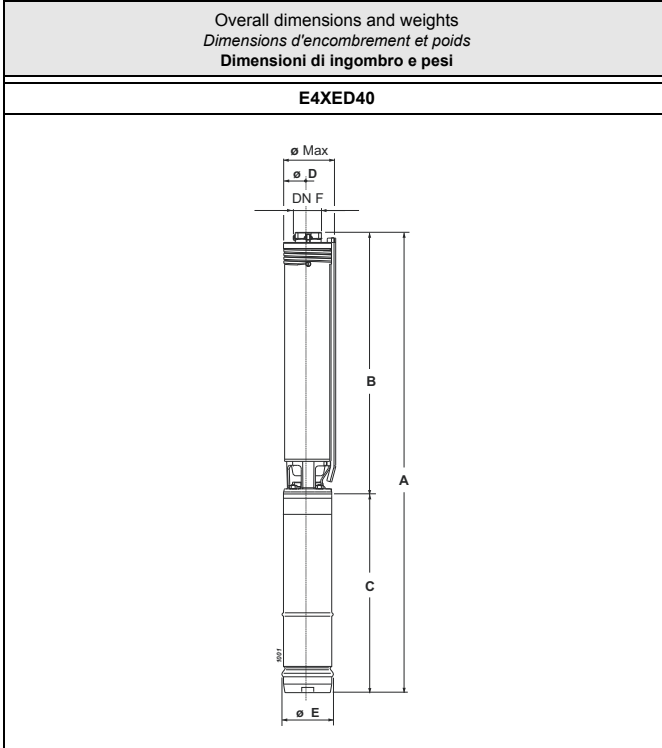

Type Type Tipo	Ø max [mm]	Weight Poids Peso [kg]	A	B	C	D	E	F
			[mm]					
E4XED40/6+MC41	98	12,5	748,5	408,5	340	93	96	G2
E4XED40/9+MCH415	98	14,6	871	521	350	93	96	G2
E4XED40/12+MCH42	98	16,1	1030,5	633,5	397	93	96	G2
E4XED40/17+MCH43	98	19,3	1285,5	848,5	437	93	96	G2
E4XED40/23+MCH44	98	23,4	1491,5	1073,5	418	93	96	G2

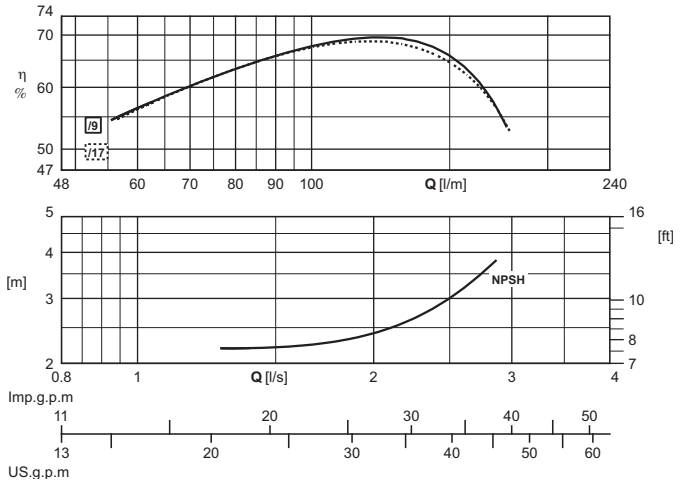
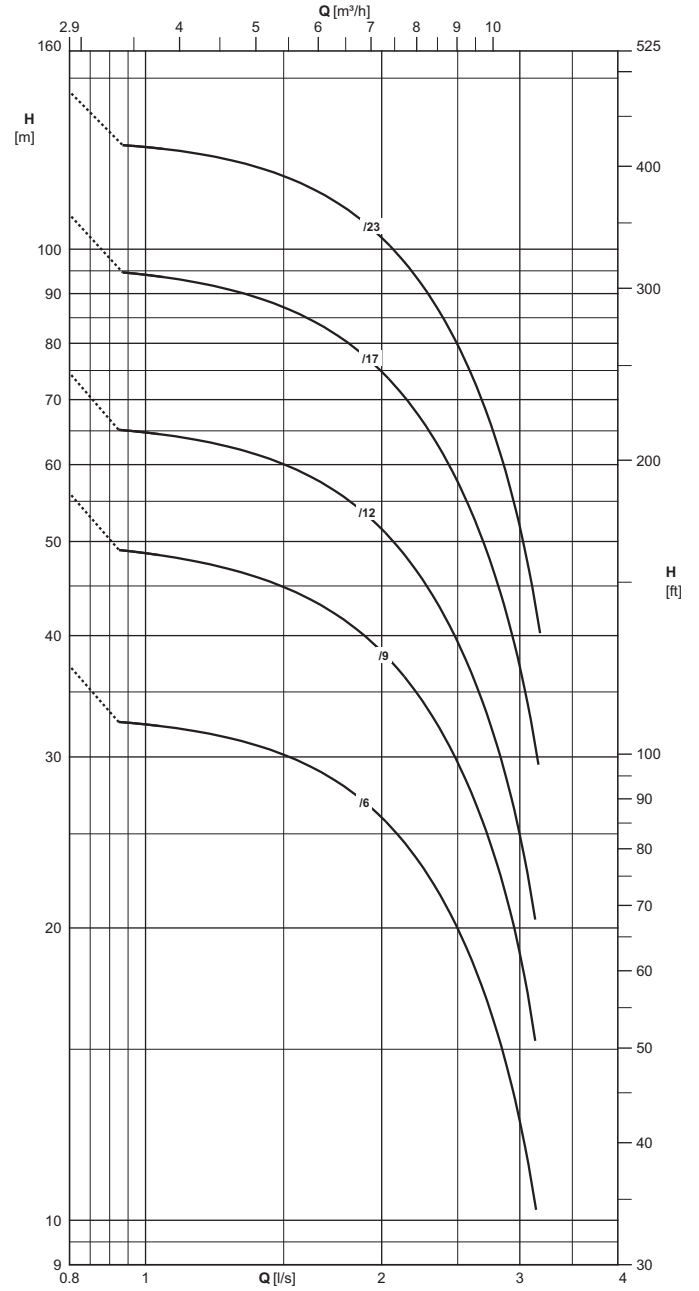

The hydraulic performance characteristics are guaranteed as conforming to standard UNI/ISO 9906 Grade 3B.

Les caractéristiques hydrauliques de fonctionnement sont garanties conformes à la norme UNI/ISO 9906 Niveau 3B.

Le caratteristiche di funzionamento vengono garantite secondo la norma: UNI/ISO 9906 Grado 3B.

Electric pump type Electropompe type Elettropompa tipo	Motor power Puis. moteur Potenza motore		Horizontal installation Installation horizontale Installazione orizzontale	Check valve Ø Clapet de retenue Ø Valvola di ritegno Ø	Capacity Debit Portata												
					[l/s]	0	1	1,2	1,4	1,6	1,8	2	2,2	2,4	2,6	2,8	3
	[l/min]	0			60	72	84	96	108	120	132	144	156	168	180		
	[m³/h]	0			3,6	4,3	5	5,8	6,5	7,2	7,9	8,6	9,4	10,1	10,8		
[kW]	[HP]	Head Hauteur Prevalenza															
E4XED40/6+MC41	0,75	1	○	2" Gas	[m]	37	32,5	32	31	29,5	28	26	23,5	20,5	19	16	12
E4XED40/9+MCH415	1,1	1,5	○	2" Gas	[m]	56	48,5	47,5	46	43,5	41,5	39	35	31	28,5	23,5	18,5
E4XED40/12+MCH42	1,5	2	○	2" Gas	[m]	74	64	64	61	58	55	52	47	41	38	31,5	24,5
E4XED40/17+MCH43	2,2	3	○	2" Gas	[m]	108	94	92	89	84	81	75	67	61	54	45	37,5
E4XED40/23+MCH44	3	4	○	2" Gas	[m]	145	127	125	121	115	111	103	92	87	75	62	51
NPSH					[m]	-	-	-	2,2	2,2	2,3	2,4	2,6	2,8	3,1	3,6	-

M.E.I. ≥ 0.40

■ Without conical valve

□ On request

○ Please contact our sales organisation

For motor performances specification see page "motor features"

Temperature monitoring device for submersed electric motors 4" + 6": see page "Accessories"

■ Sans soupape du clapet.

□ Sur demande

○ Contacter notre service commercial.

Pour caracteristiques techniques moteurs voir page "Caracteristiques des moteurs"

Appareillage de contrôle de la température des moteurs électriques immergés 4" + 6": voir page "Accessories"

■ Senza clapet valvola di ritegno

□ Su richiesta

○ Interpellare la sede o la rete di vendita

Per caratteristiche motori vedere pagina caratteristiche motori

Apparecchiatura di controllo temperatura motori elettrici sommersi 4" + 6": vedere pagina accessori

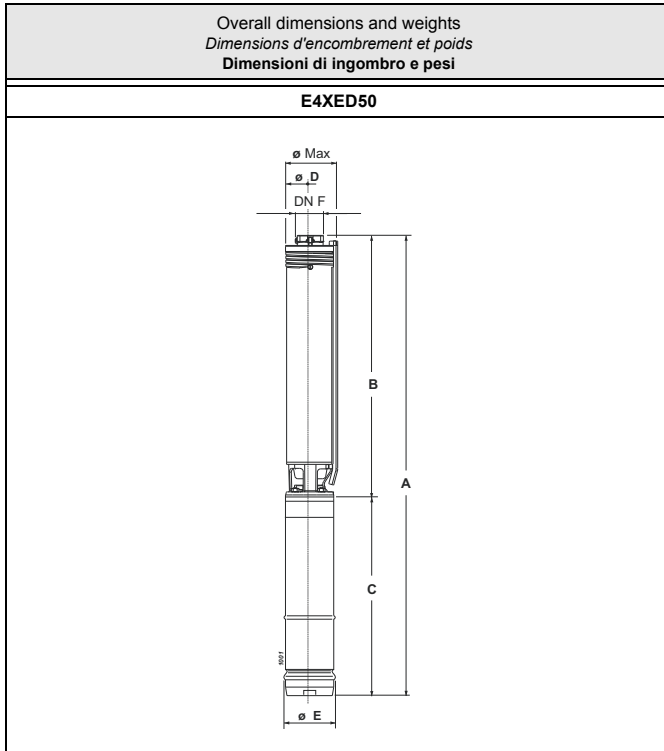

Type Type Tipo	Ø max [mm]	Weight Poids Peso [kg]	A	B	C	D	E	F
			[mm]					
E4XED50/6+MCH415	98	14,1	788,5	438,5	350	93	96	G2
E4XED50/8+MCH42	98	15,4	920,5	523,5	397	93	96	G2
E4XED50/12+MCH43	98	18,5	1158	721	437	93	96	G2
E4XED50/16+MCH44	98	22,3	1309	891	418	93	96	G2
E4XED50/22+MCH455	98	27,5	1614	1146	468	93	96	G2

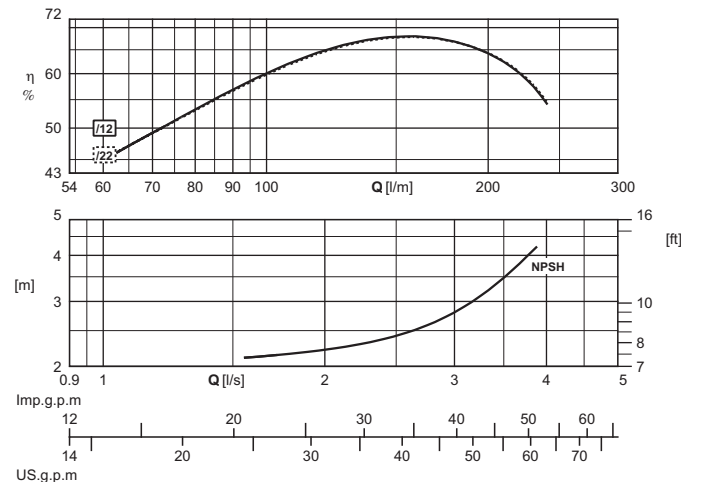
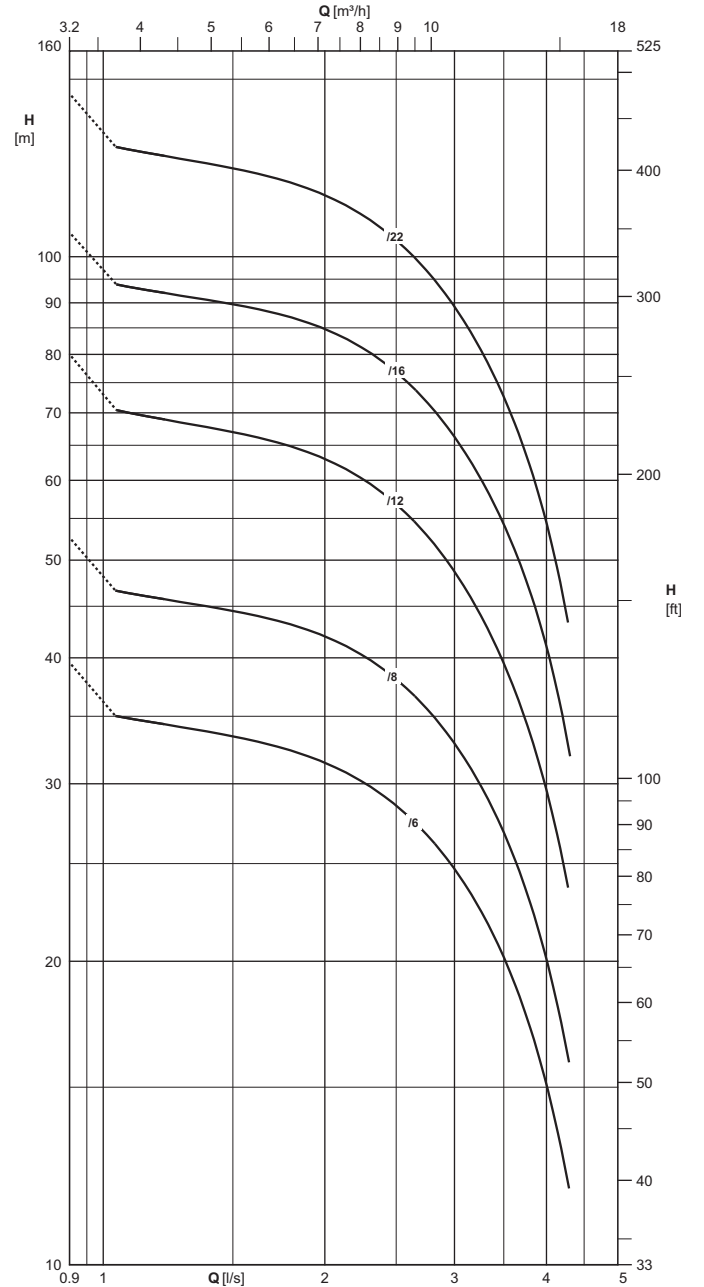

The hydraulic performance characteristics are guaranteed as conforming to standard UNI/ISO 9906 Grade 3B.

Les caractéristiques hydrauliques de fonctionnement sont garanties conformes à la norme UNI/ISO 9906 Niveau 3B.

Le caratteristiche di funzionamento vengono garantite secondo la norma: UNI/ISO 9906 Grado 3B.

Electric pump type Electropompe type Elettropompa tipo	Motor power Puis. moteur Potenza motore		Horizontal installation Installation horizontale Installazione orizzontale	Check valve Ø Clapet de retenue Ø Valvola di ritegno Ø	Capacity Debit Portata													
					[l/s]	0	1,2	1,4	1,6	1,8	2	2,2	2,4	2,6	2,8	3	3,5	4
	[l/min]	0			72	84	96	108	120	132	144	156	168	180	210	240		
	[m³/h]	0			4,3	5	5,8	6,5	7,2	7,9	8,6	9,4	10,1	10,8	12,6	14,4		
[kW]	[HP]	Head Hauteur Prevalenza																
E4XED50/6+MCH415	1,1	1,5	○	2" Gas	[m]	39,5	34,5	34	33,5	32,5	31,5	30	29	28	26,5	24,5	20	15,5
E4XED50/8+MCH42	1,5	2	○	2" Gas	[m]	53	45,5	45	44,5	43	42	40,5	39	37,5	35,5	33	26,5	21
E4XED50/12+MCH43	2,2	3	○	2" Gas	[m]	80	69	68	66	65	63	60	58	56	52	48,5	39	29
E4XED50/16+MCH44	3	4	○	2" Gas	[m]	106	92	90	89	87	85	81	78	75	71	66	53	42
E4XED50/22+MCH455	4	5,5	○	2" Gas	[m]	145	126	124	122	118	115	110	106	102	94	89	72	53
NPSH					[m]	-	-	-	2,1	2,2	2,3	2,4	2,5	2,6	2,8	3,5	4,4	

M.E.I. ≥ 0.40

■ Without conical valve

□ On request

○ Please contact our sales organisation

For motor performances specification see page "motor features"

Temperature monitoring device for submersed electric motors 4" + 6": see page "Accessories"

■ Sans soupape du clapet.

□ Sur demande

○ Contacter notre service commercial.

Pour caracteristiques techniques moteurs voir page "Caracteristiques des moteurs"

Appareillage de contrôle de la température des moteurs électriques immergés 4" + 6": voir page "Accessories"

■ Senza clapet valvola di ritegno

□ Su richiesta

○ Interpellare la sede o la rete di vendita

Per caratteristiche motori vedere pagina caratteristiche motori

Apparecchiatura di controllo temperatura motori elettrici sommersi 4" + 6": vedere pagina accessori

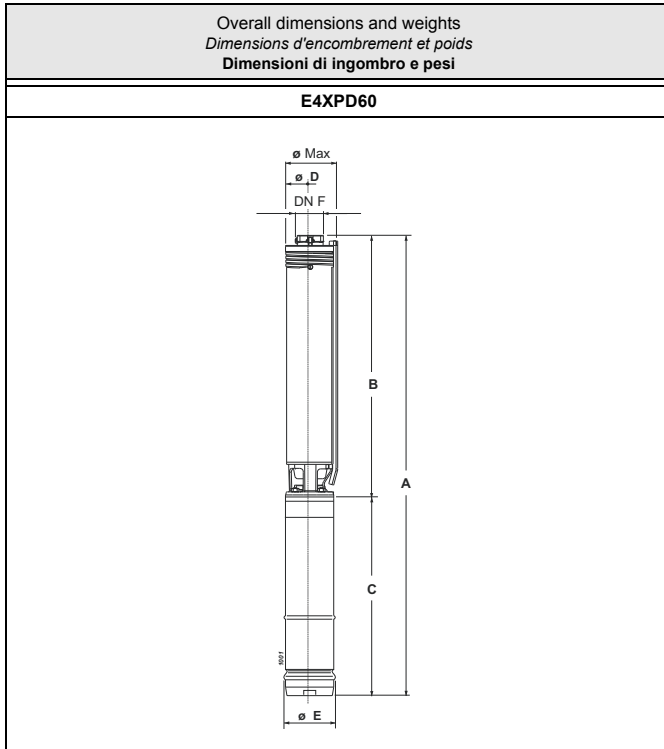

Type Type Tipo	Ø max [mm]	Weight Poids Peso [kg]	A	B	C	D	E	F
			[mm]					
E4XPD60/5+MCH42	98	15,6	955	558	397	93	96	G2
E4XPD60/7+MCH43	98	18,2	1131	694	437	93	96	G2
E4XPD60/10+MCH44	98	22,4	1343,5	925,5	418	93	96	G2
E4XPD60/13+MCH455	98	27,1	1597,5	1129,5	468	93	96	G2
E4XPD60/18+MCR475	98	35,7	2197	1497	700	93	96	G2
E4XPD60/25+MCR410	98	43,2	2800,5	2000,5	800	93	96	G2

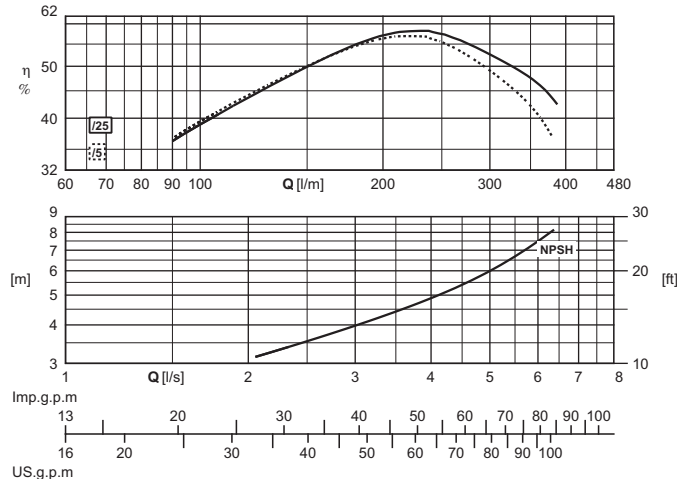
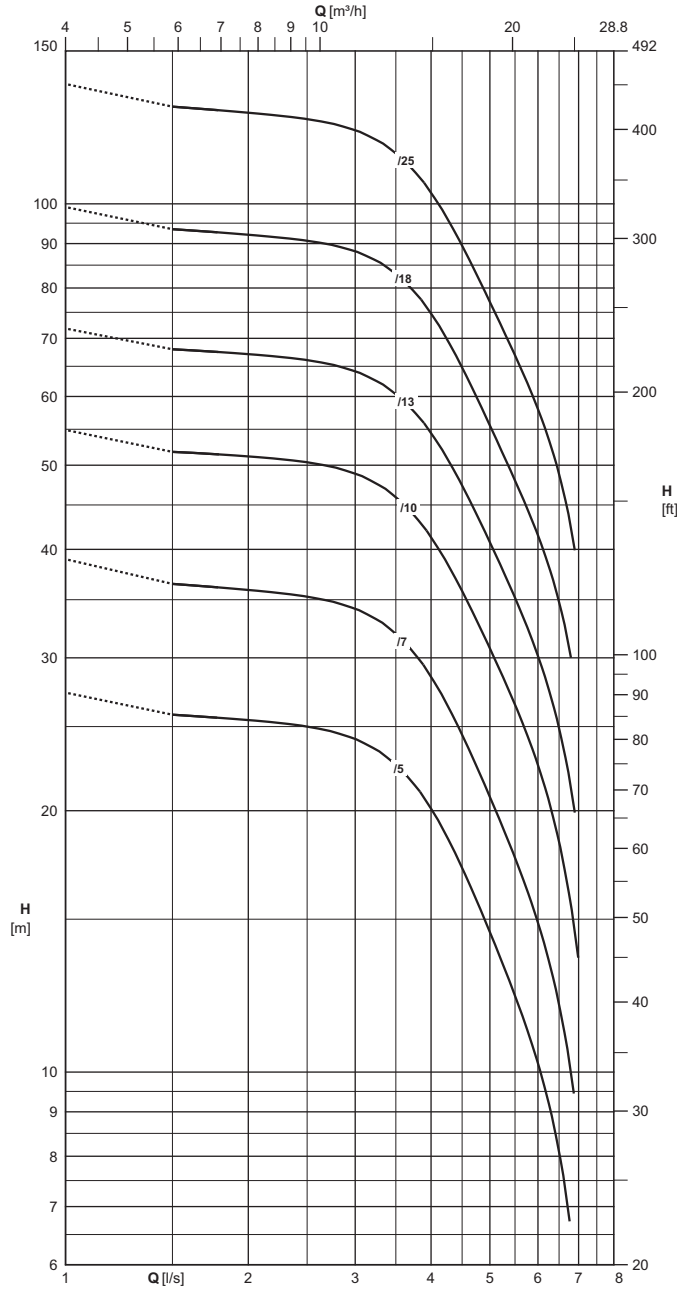

The hydraulic performance characteristics are guaranteed as conforming to standard UNI/ISO 9906 Grade 3B.

Les caractéristiques hydrauliques de fonctionnement sont garanties conformes à la norme UNI/ISO 9906 Niveau 3B.

Le caratteristiche di funzionamento vengono garantite secondo la norma: UNI/ISO 9906 Grado 3B.

Electric pump type Electropompe type Elettropompa tipo	Motor power Puis. moteur Potenza motore		Horizontal installation Installation horizontale Installazione orizzontale	Check valve \varnothing Clapet de retenue \varnothing Valvola di ritegno \varnothing	Capacity Debit Portata																
					[l/s]	0	1,6	1,8	2	2,2	2,4	2,6	2,8	3	3,5	4	4,5	5	5,5	6	6,5
	[l/min]	0			96	108	120	132	144	156	168	180	210	240	270	300	330	360	390		
	[m ³ /h]	0			5,8	6,5	7,2	7,9	8,6	9,4	10,1	10,8	12,6	14,4	16,2	18	19,8	21,6	23,4		
[kW]	[HP]	Head Hauteur Prevalenza																			
E4XPD60/5+MCH42	1,5	2	<input type="radio"/>	2" Gas	[m]	27,5	25,5	25,5	25,5	25,5	25	25	24,5	24	22,5	20	17	14,5	12,5	10	8,2
E4XPD60/7+MCH43	2,2	3	<input type="radio"/>	2" Gas	[m]	39	36,5	36	36	35,5	35,5	35	34,5	34	32	28	24,5	21	18	14,5	12
E4XPD60/10+MCH44	3	4	<input type="radio"/>	2" Gas	[m]	55	52	51	51	51	51	50	49,5	48,5	46	41	36	31	26	22,5	18,5
E4XPD60/13+MCH455	4	5,5	<input type="radio"/>	2" Gas	[m]	72	68	67	67	67	66	66	65	64	60	55	47	40,5	35,5	29,5	24,5
E4XPD60/18+MCR475	5,5	7,5	<input type="radio"/>	2" Gas	[m]	99	93	93	92	91	91	90	89	88	84	74	65	55	48	42	34,5
E4XPD60/25+MCR410	7,5	10	<input type="radio"/>	2" Gas	[m]	137	129	128	127	127	126	124	123	121	114	104	89	77	67	57	48,5
NPSH					[m]	-	-	-	-	3,3	3,4	3,6	3,8	4	4,4	4,9	5,5	5,9	6,7	7,5	8,4

Without conical valve

On request

Please contact our sales organisation

For motor performances specification see page "motor features"

Temperature monitoring device for submersed electric motors 4" + 6":
Appareillage de contrôle de la température des moteurs électriques
immersés 4" + 6": voir page "Accessories"

Sans soupape du clapet.

Sur demande

Contacter notre service commercial.

Pour caractéristiques techniques moteurs voir page "Caractéristiques des moteurs"

Senza clapet valvola di ritegno

Su richiesta

Interpellare la sede o la rete di vendita

Per caratteristiche motori vedere pagina caratteristiche motori

Apparecchiatura di controllo temperatura motori elettrici sommersi 4" + 6": vedere pagina accessori

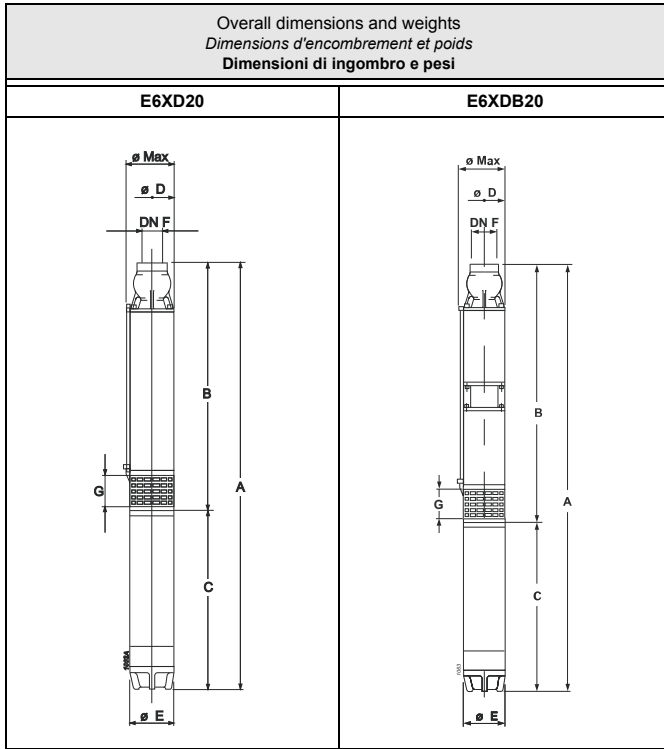

Type Type Tipo	Ø max	Weight Poids Peso	A	B	C	D	E	G	F
	[mm]								
E6XD20/9+MCH415	135	21	918	568	350	127	96	-	G2 1/2
E6XD20/12+MCH42	135	23,5	1055	658	397	127	96	-	G2 1/2
E6XD20/18+MCK43	135	28,5	1334	897	437	127	96	-	G2 1/2
E6XD20/24+MCR44	135	37,5	1597	1077	520	127	96	-	G2 1/2
E6XD20/30+MCR455	135	44	1867	1257	610	127	96	-	G2 1/2
E6XD20/30+MAC65A	145	53	1822	1292	530	141	143	100	G2 1/2
E6XDB20/36+MAC67A	145	59	2214	1664	550	141	143	100	G2 1/2
E6XDB20/40+MAC67A	145	61	2334	1784	550	141	143	100	G2 1/2
E6XDB20/44+MAC67A	145	63,5	2454	1904	550	141	143	100	G2 1/2
E6XDB20/50+MAC610A	145	71,5	2679	2084	595	141	143	100	G2 1/2
E6XDB20/56+MAC610A	145	75	2859	2264	595	141	143	100	G2 1/2
E6XDB20/63+MAC612A	145	82,5	3114	2474	640	141	143	100	G2 1/2
E6XDB20/70+MAC612A	145	86,5	3324	2684	640	141	143	100	G2 1/2
E6XDB20/76+MAC615A	145	92,5	3534	2864	670	141	143	100	G2 1/2

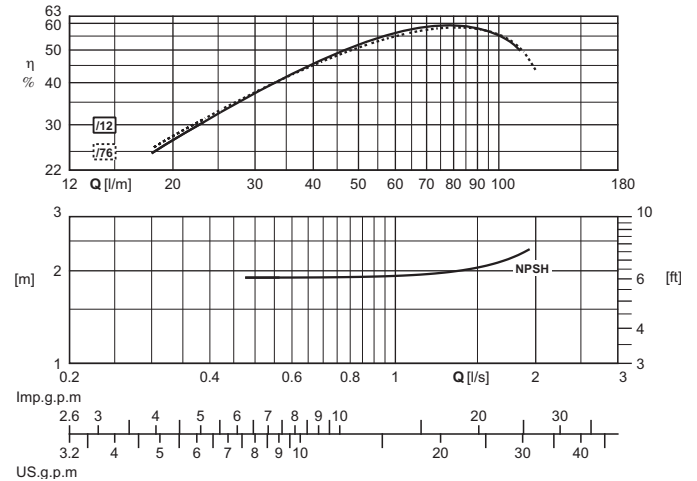
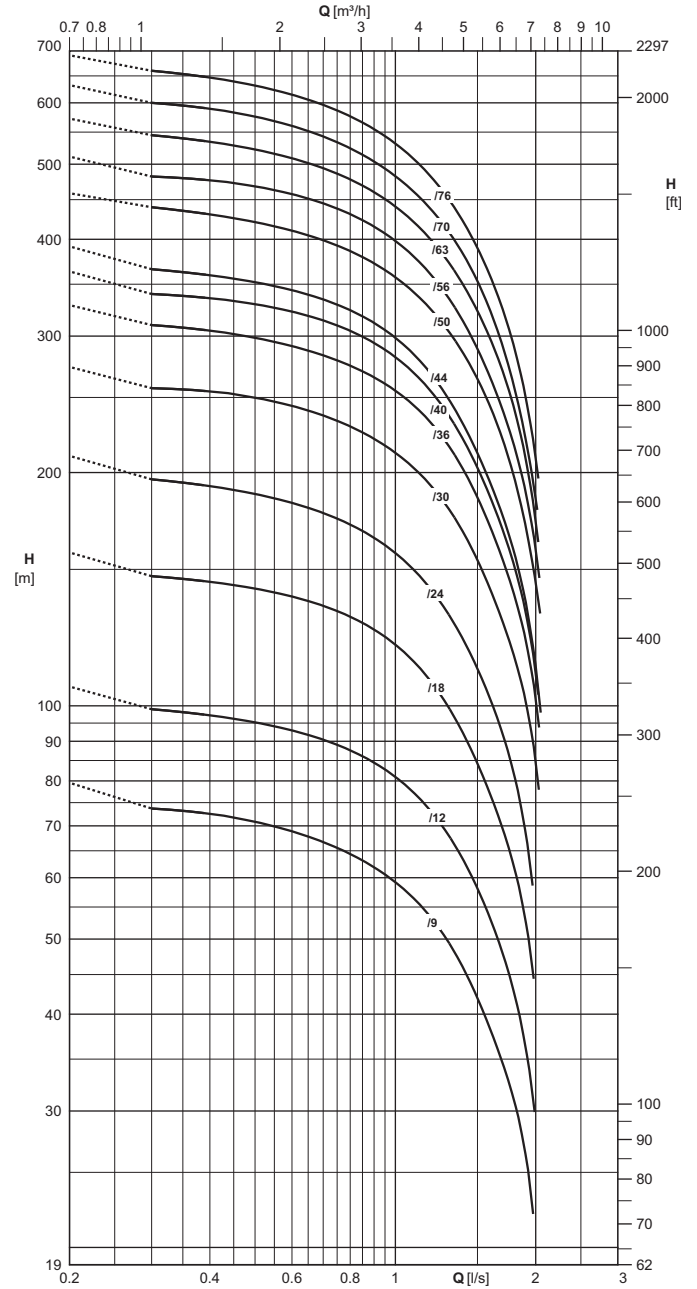

The hydraulic performance characteristics are guaranteed as conforming to standard UNI/ISO 9906 Grade 3B.
The hydraulic characteristics of units coupled to MAC 6../2B 6" motors are guaranteed as conforming to standard UNI/ISO 9906 Grade 2B.

Les caractéristiques hydrauliques de fonctionnement sont garanties conformes à la norme UNI/ISO 9906 Niveau 3B.
Pour les groupes accouplés à des moteurs 6" MAC 6../2B les caractéristiques hydrauliques sont garanties conformes à la norme UNI/ISO 9906 Niveau 2B.

Le caratteristiche idrauliche di funzionamento vengono garantite secondo la norma UNI/ISO 9906 Grado 3B.
Per i gruppi accoppiati a motori 6" MAC 6../2B le caratteristiche idrauliche vengono garantite secondo la norma UNI/ISO 9906 Grado 2B.

Electric pump type Electropompe type Elettropompa tipo	Motor power Puis. moteur Potenza motore		Horizontal installation Installation horizontale Installazione orizzontale	Check valve \varnothing Clapet de retenue \varnothing Valvola di ritegno \varnothing	Capacity Debit Portata														
	[kW]	[HP]			[l/s]	0	0,3	0,4	0,5	0,6	0,7	0,8	0,9	1	1,2	1,4	1,6	1,8	2
					[l/min]	0	18	24	30	36	42	48	54	60	72	84	96	108	120
					[m ³ /h]	0	1,1	1,4	1,8	2,2	2,5	2,9	3,2	3,6	4,3	5	5,8	6,5	7,2
Head Hauteur Prevalenza																			
E6XD20/9+MCH415	1,1	1,5	■	2 1/2" Gas	[m]	79	74	73	71	69	68	64	61	59	54	47,5	37,5	31	22
E6XD20/12+MCH42	1,5	2	■	2 1/2" Gas	[m]	106	99	97	96	94	91	86	84	80	73	65	51	42	30
E6XD20/18+MCK43	2,2	3	■	2 1/2" Gas	[m]	158	147	145	142	139	136	129	124	119	108	95	75	61	44,5
E6XD20/24+MCR44	3	4	■	2 1/2" Gas	[m]	210	196	192	189	184	180	169	164	157	142	126	100	82	59
E6XD20/30+MCR455	4	5,5	■	2 1/2" Gas	[m]	274	257	255	251	245	239	233	218	209	190	168	144	121	78
E6XD20/30+MAC65A	4	5,5	■	2 1/2" Gas	[m]	274	257	255	251	245	239	233	218	209	190	168	144	121	78
E6XDB20/36+MAC67A	5,5	7,5	■	2 1/2" Gas	[m]	329	310	305	300	293	286	279	261	252	229	202	173	145	94
E6XDB20/40+MAC67A	5,5	7,5	■	2 1/2" Gas	[m]	364	340	336	331	325	317	309	290	278	252	222	190	159	103
E6XDB20/44+MAC67A	5,5	7,5	■	2 1/2" Gas	[m]	392	366	360	353	346	338	328	318	293	263	229	195	162	123
E6XDB20/50+MAC610A	7,5	10	■	2 1/2" Gas	[m]	459	440	431	423	413	403	391	379	352	320	284	246	204	157
E6XDB20/56+MAC610A	7,5	10	■	2 1/2" Gas	[m]	511	482	477	470	460	449	437	409	392	355	314	270	225	146
E6XDB20/63+MAC612A	9,2	12,5	○	2 1/2" Gas	[m]	572	545	535	525	513	500	485	453	435	396	351	305	255	163
E6XDB20/70+MAC612A	9,2	12,5	○	2 1/2" Gas	[m]	632	600	591	579	565	550	533	497	477	434	387	334	245	179
E6XDB20/76+MAC615A	11	15	○	2 1/2" Gas	[m]	691	660	648	634	619	603	586	547	525	477	424	367	306	196
NPSH					[m]	-	-	-	1,9	1,9	1,9	1,9	1,9	1,9	2	2	2,1	2,2	2,4

M.E.I. \geq 0.40

■ Without conical valve

□ On request

○ Please contact our sales organisation

For motor performances specification see page "motor features"

■ Sans soupape du clapet.

□ Sur demande

○ Contacter notre service commercial.

Pour caractéristiques techniques moteurs voir page "Caractéristiques des moteurs"

■ Senza clapet valvola di ritegno

□ Su richiesta

○ Interpellare la sede o la rete di vendita

Per caratteristiche motori vedere pagina caratteristiche motori

Temperature monitoring device for submersed electric motors 4" + 6": see page "Accessories"

Appareillage de contrôle de la température des moteurs électriques immergés 4" + 6": voir page "Accessories"

Apparecchiatura di controllo temperatura motori elettrici sommersi 4" + 6": vedere pagina accessori

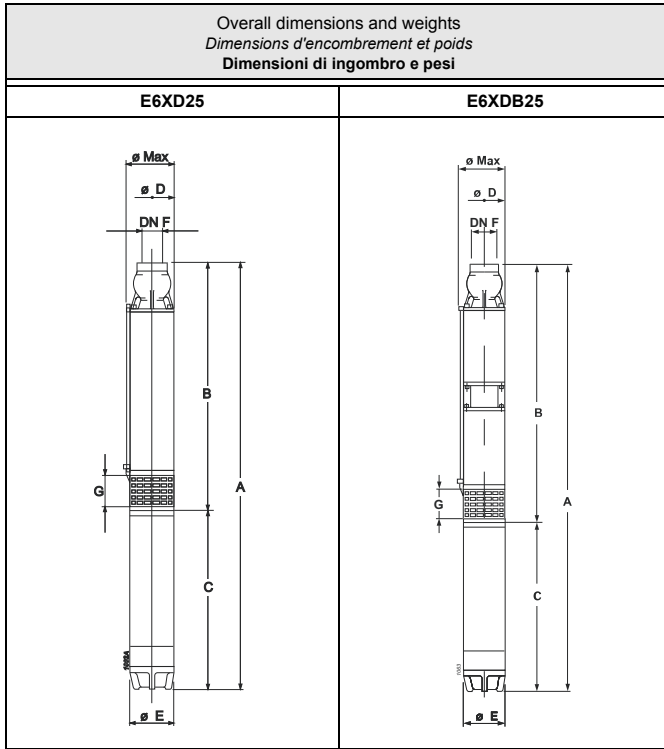

Type Type Tipo	\varnothing max	Weight Poids Peso	A	B	C	D	E	G	F
	[mm]	[kg]	[mm]						
E6XD25/7+MCH42	135	22	905	508	397	127	96	-	G2 1/2
E6XD25/10+MCH43	135	25	1035	598	437	127	96	-	G2 1/2
E6XD25/13+MCH44	135	29	1106	688	418	127	96	-	G2 1/2
E6XD25/17+MCR455	135	37,5	1477	867	610	127	96	-	G2 1/2
E6XD25/17+MAC65A	145	46,5	1432	902	530	141	143	100	G2 1/2
E6XD25/21+MCR475	135	42,5	1687	987	700	127	96	-	G2 1/2
E6XD25/21+MAC67A	145	51	1572	1022	550	141	143	100	G2 1/2
E6XD25/24+MCR475	135	44	1777	1077	700	127	96	-	G2 1/2
E6XD25/24+MAC67A	145	52,5	1662	1112	550	141	143	100	G2 1/2
E6XD25/28+MAC610A	145	59,5	1827	1232	595	141	143	100	G2 1/2
E6XD25/32+MAC610A	145	61,5	1947	1352	595	141	143	100	G2 1/2
E6XDB25/36+MAC612A	145	67,5	2304	1664	640	141	143	100	G2 1/2
E6XDB25/40+MAC612A	145	69,5	2424	1784	640	141	143	100	G2 1/2
E6XDB25/44+MAC615A	145	74	2574	1904	670	141	143	100	G2 1/2
E6XDB25/50+MAC615A	145	77	2754	2084	670	141	143	100	G2 1/2
E6XDB25/56+MAC617A	145	83,5	2964	2264	700	141	143	100	G2 1/2
E6XDB25/63+MAC620A	145	91	3189	2474	715	141	143	100	G2 1/2

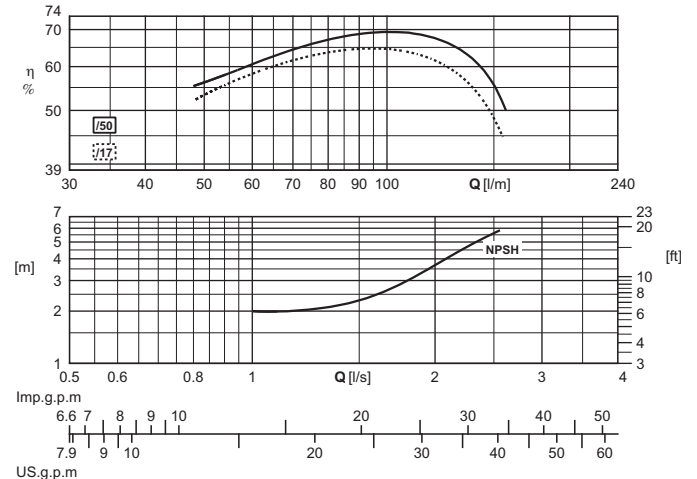
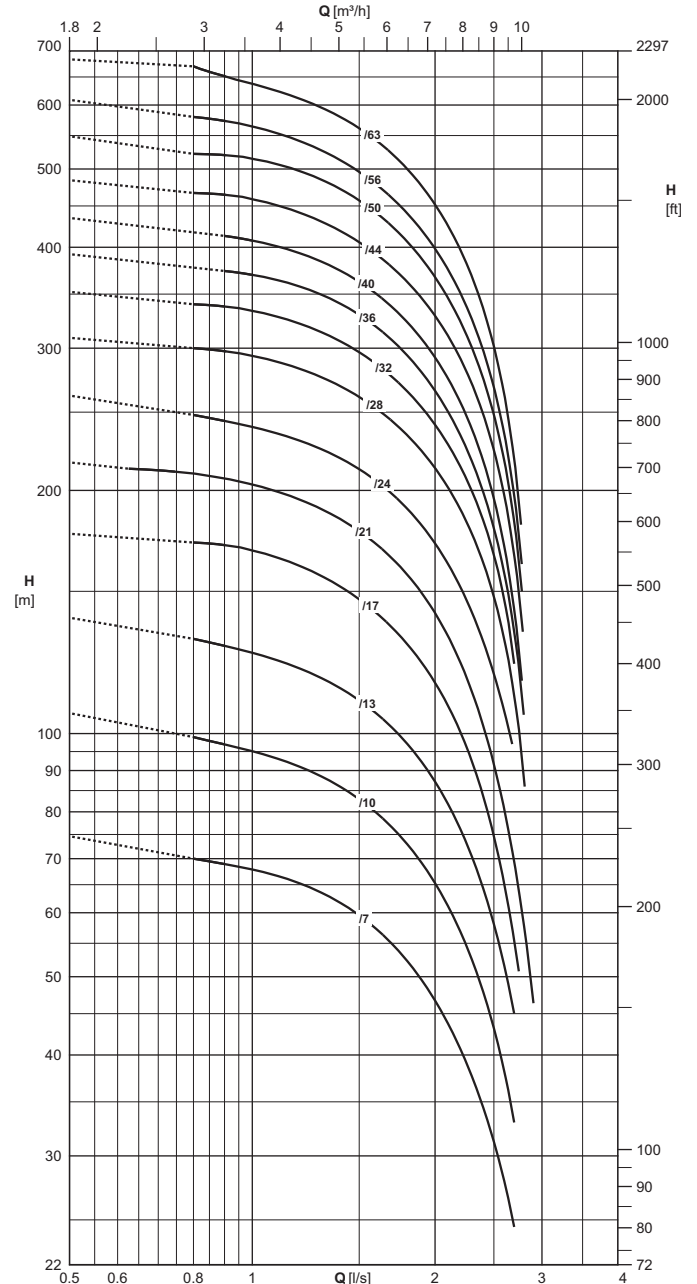

The hydraulic performance characteristics are guaranteed as conforming to standard UNI/ISO 9906 Grade 3B.
The hydraulic characteristics of units coupled to MAC 6../2B 6" motors are guaranteed as conforming to standard UNI/ISO 9906 Grade 2B.

Les caractéristiques hydrauliques de fonctionnement sont garanties conformes à la norme UNI/ISO 9906 Niveau 3B.
Pour les groupes accouplés à des moteurs 6" MAC 6../2B les caractéristiques hydrauliques sont garanties conformes à la norme UNI/ISO 9906 Niveau 2B.

Le caratteristiche idrauliche di funzionamento vengono garantite secondo la norma UNI/ISO 9906 Grado 3B.
Per i gruppi accoppiati a motori 6" MAC 6../2B le caratteristiche idrauliche vengono garantite secondo la norma UNI/ISO 9906 Grado 2B.

Electric pump type Electropompe type Elettropompa tipo	Motor power Puis. moteur Potenza motore		Horizontal installation Installation horizontale Installazione orizzontale	Check valve \varnothing Clapet de retenue \varnothing Valvola di ritegno \varnothing	Capacity Debit Portata														
	[kW]	[HP]			[l/s]	0	0,7	0,8	0,9	1	1,2	1,4	1,6	1,8	2	2,2	2,4	2,6	2,8
					[l/min]	0	42	48	54	60	72	84	96	108	120	132	144	156	168
					[m ³ /h]	0	2,5	2,9	3,2	3,6	4,3	5	5,8	6,5	7,2	7,9	8,6	9,4	10,1
Head Hauteur Prevalenza																			
E6XD25/7+MCH42	1,5	2	■	2 1/2" Gas	[m]	74	-	70	69	68	65	62	57	52	46,5	40,5	34,5	28	-
E6XD25/10+MCH43	2,2	3	■	2 1/2" Gas	[m]	106	-	99	97	95	91	86	80	73	65	57	48	38	-
E6XD25/13+MCH44	3	4	■	2 1/2" Gas	[m]	139	-	131	128	126	120	114	106	97	87	76	64	52	-
E6XD25/17+MCR455	4	5,5	■	2 1/2" Gas	[m]	177	-	172	171	168	161	151	140	127	113	98	80	61	-
E6XD25/17+MAC65A	4	5,5	■	2 1/2" Gas	[m]	187	-	178	175	172	165	157	148	136	124	110	94	78	-
E6XD25/21+MCR475	5,5	7,5	○	2 1/2" Gas	[m]	216	211	209	208	204	193	184	172	155	140	124	100	80	60
E6XD25/21+MAC67A	5,5	7,5	■	2 1/2" Gas	[m]	231	-	219	215	212	203	193	182	168	153	136	117	96	-
E6XD25/24+MCR475	5,5	7,5	○	2 1/2" Gas	[m]	262	-	248	244	240	230	219	206	191	173	153	132	109	-
E6XD25/24+MAC67A	5,5	7,5	■	2 1/2" Gas	[m]	262	-	248	244	240	230	219	206	191	173	153	132	109	-
E6XD25/28+MAC610A	7,5	10	■	2 1/2" Gas	[m]	309	-	300	297	293	281	266	248	239	217	193	165	131	86
E6XD25/32+MAC610A	7,5	10	■	2 1/2" Gas	[m]	352	-	340	338	334	321	306	287	265	241	214	184	147	-
E6XDB25/36+MAC612A	9,2	12,5	■	2 1/2" Gas	[m]	392	-	-	374	370	357	340	319	294	266	234	199	158	105
E6XDB25/40+MAC612A	9,2	12,5	■	2 1/2" Gas	[m]	435	-	-	413	408	393	374	351	324	294	260	221	175	116
E6XDB25/44+MAC615A	11	15	■	2 1/2" Gas	[m]	484	-	467	464	458	439	415	387	355	337	299	255	203	134
E6XDB25/50+MAC615A	11	15	■	2 1/2" Gas	[m]	549	-	522	520	514	495	468	436	398	367	334	285	227	150
E6XDB25/56+MAC617A	13	17,5	○	2 1/2" Gas	[m]	609	-	580	573	563	539	508	472	432	387	363	309	245	162
E6XDB25/63+MAC620A	15	20	○	2 1/2" Gas	[m]	683	-	670	651	637	608	575	536	491	440	397	350	277	181
NPSH					[m]	-	-	-	-	2	2	2,2	2,5	3	3,6	4,2	4,9	5,8	-

M.E.I. \geq 0.40

■ Without conical valve

□ On request

○ Please contact our sales organisation

For motor performances specification see page "motor features"

■ Sans soupape du clapet.

□ Sur demande

○ Contacter notre service commercial.

Pour caractéristiques techniques moteurs voir page "Caractéristiques des moteurs"

■ Senza clapet valvola di ritegno

□ Su richiesta

○ Interpellare la sede o la rete di vendita

Per caratteristiche motori vedere pagina caratteristiche motori

Temperature monitoring device for submersed electric motors 4" + 6": Appareillage de contrôle de la température des moteurs électriques immergés 4" + 6": voir page "Accessories"

Apparecchiatura di controllo temperatura motori elettrici sommersi 4" + 6": vedere pagina accessori

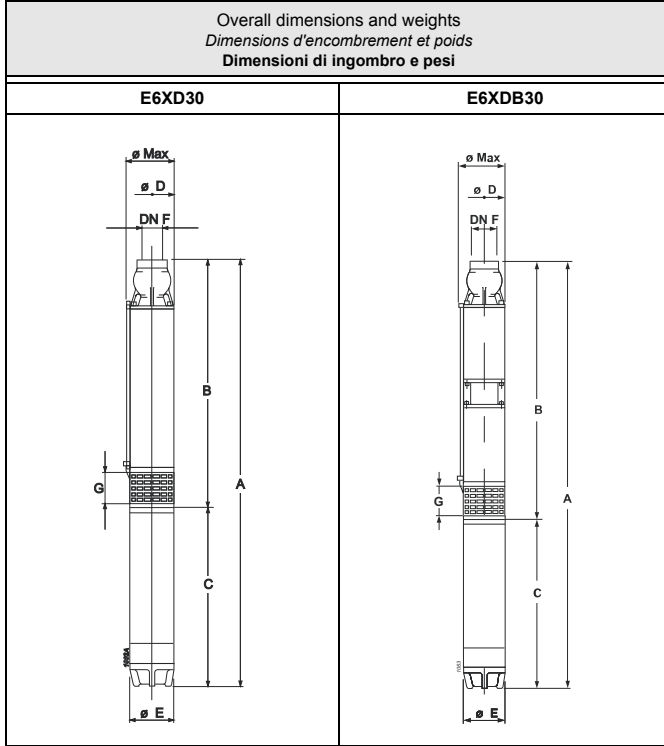

Type Type Tipo	Ø max	Weight Poids Peso	A	B	C	D	E	G	F
	[mm]								
E6XD30/5+MCH42	135	21	870	473	397	127	96	-	G2 1/2
E6XD30/8+MCH43	135	24,5	1015	578	437	127	96	-	G2 1/2
E6XD30/10+MCH44	135	28,5	1066	648	418	127	96	-	G2 1/2
E6XD30/13+MCH455	135	34	1280	812	468	127	96	-	G2 1/2
E6XD30/13+MAC65A	145	46	1377	847	530	141	143	100	G2 1/2
E6XD30/16+MCR475	135	42	1617	917	700	127	96	-	G2 1/2
E6XD30/16+MAC67A	145	50,5	1502	952	550	141	143	100	G2 1/2
E6XD30/18+MCR475	135	43,5	1687	987	700	127	96	-	G2 1/2
E6XD30/18+MAC67A	145	52	1572	1022	550	141	143	100	G2 1/2
E6XD30/21+MCR410	135	49,5	1892	1092	800	127	96	-	G2 1/2
E6XD30/21+MAC610A	145	59	1722	1127	595	141	143	100	G2 1/2
E6XD30/24+MCR410	135	51,5	1997	1197	800	127	96	-	G2 1/2
E6XD30/24+MAC610A	145	61	1827	1232	595	141	143	100	G2 1/2
E6XD30/28+MAC612A	145	67,5	2012	1372	640	141	143	100	G2 1/2
E6XD30/31+MAC612A	145	69,5	2117	1477	640	141	143	100	G2 1/2
E6XD30/36+MAC615A	145	75,5	2322	1652	670	141	143	100	G2 1/2
E6XDB30/42+MAC617A	145	83	2754	2054	700	141	143	100	G2 1/2
E6XDB30/47+MAC620A	145	90,5	2944	2229	715	141	143	100	G2 1/2
E6XDB30/52+MAC625A	145	98	3154	2404	750	141	143	100	G2 1/2
E6XDB30/56+MAC625A	145	101	3294	2544	750	141	143	100	G2 1/2
E6XDB30/60+MAC625A	145	103,5	3434	2684	750	141	143	100	G2 1/2
E6XDB30/65+MAC630A	145	110,5	3649	2859	790	141	143	100	G2 1/2

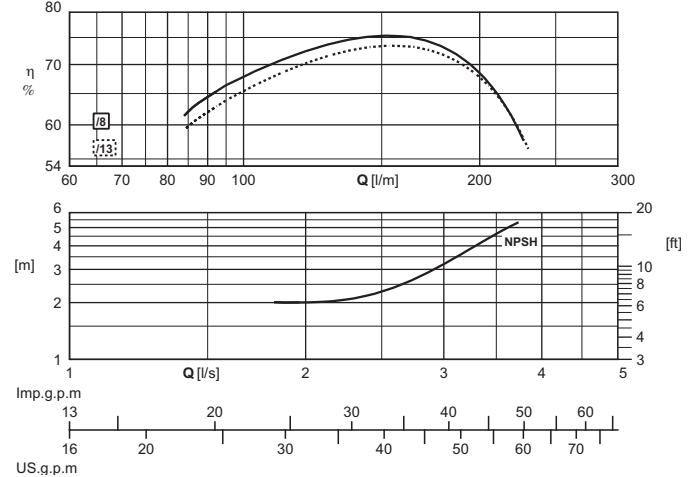
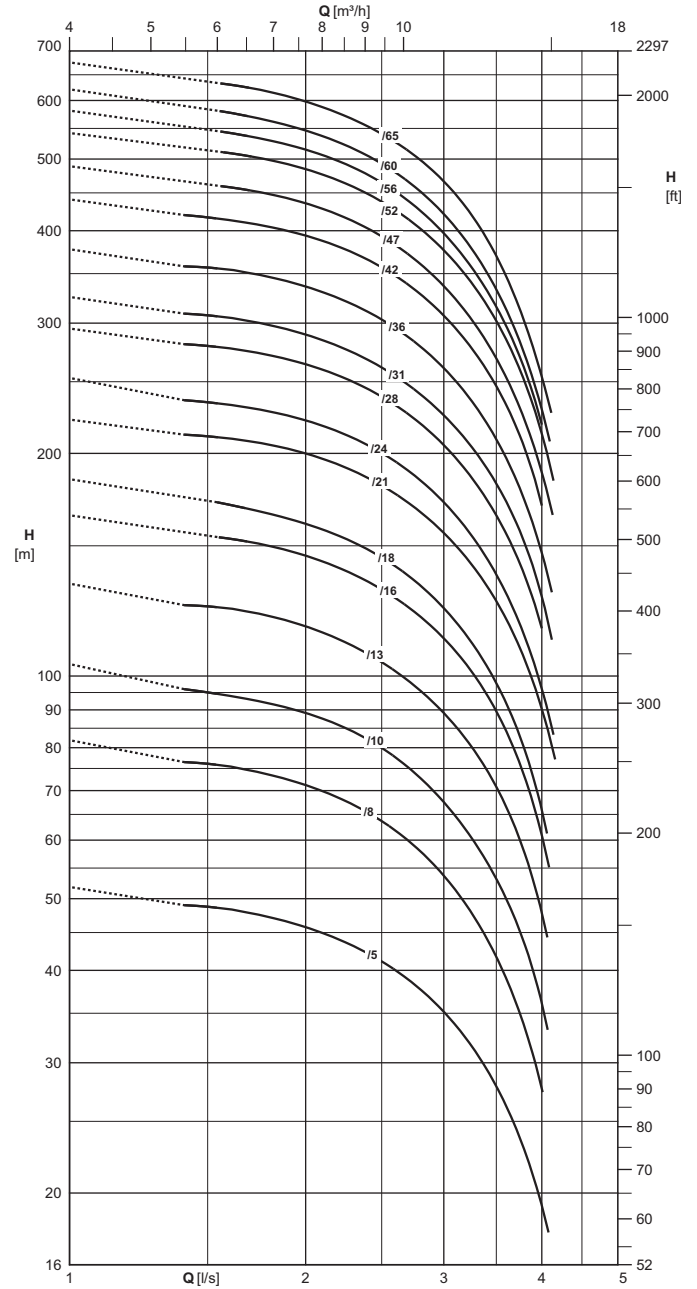

The hydraulic performance characteristics are guaranteed as conforming to standard UNI/ISO 9906 Grade 3B.
The hydraulic characteristics of units coupled to MAC 6../2B 6" motors are guaranteed as conforming to standard UNI/ISO 9906 Grade 2B.

Les caractéristiques hydrauliques de fonctionnement sont garanties conformes à la norme UNI/ISO 9906 Niveau 3B.
Pour les groupes accouplés à des moteurs 6" MAC 6../2B les caractéristiques hydrauliques sont garanties conformes à la norme UNI/ISO 9906 Niveau 2B.

Le caratteristiche idrauliche di funzionamento vengono garantite secondo la norma UNI/ISO 9906 Grado 3B.
Per i gruppi accoppiati a motori 6" MAC 6../2B le caratteristiche idrauliche vengono garantite secondo la norma UNI/ISO 9906 Grado 2B.

Electric pump type Electropompe type Elettropompa tipo	Motor power Puisse. moteur Potenza motore		Horizontal installation Installation horizontale Installazione orizzontale	Check valve \varnothing Clapet de retenue \varnothing Valvola di ritegno \varnothing	Capacity Debit Portata												
					[l/s]	0	1,4	1,6	1,8	2	2,2	2,4	2,6	2,8	3	3,5	4
	[l/min]	0			84	96	108	120	132	144	156	168	180	210	240		
	[m ³ /h]	0			5	5,8	6,5	7,2	7,9	8,6	9,4	10,1	10,8	12,6	14,4		
[kW]	[HP]	Head Hauteur Prevalenza															
E6XD30/5+MCH42	1,5	2	■	2 1/2" Gas	[m]	52	49	48,5	47	46	43,5	42,5	40	37,5	36	27,5	19
E6XD30/8+MCH43	2,2	3	■	2 1/2" Gas	[m]	82	76	75	73	71	68	66	61	58	53	42,5	27,5
E6XD30/10+MCH44	3	4	■	2 1/2" Gas	[m]	104	96	94	91	90	85	82	78	73	67	53	36
E6XD30/13+MCH455	4	5,5	■	2 1/2" Gas	[m]	133	125	123	120	117	111	107	102	95	88	71	48
E6XD30/13+MAC65A	4	5,5	■	2 1/2" Gas	[m]	137	131	129	126	123	119	113	109	101	96	77	55
E6XD30/16+MCR475	5,5	7,5	○	2 1/2" Gas	[m]	165	-	154	149	146	140	136	127	122	112	90	64
E6XD30/16+MAC67A	5,5	7,5	■	2 1/2" Gas	[m]	168	160	157	154	151	145	139	134	123	117	94	67
E6XD30/18+MCR475	5,5	7,5	○	2 1/2" Gas	[m]	184	-	170	165	160	155	148	141	132	123	96	66
E6XD30/18+MAC67A	5,5	7,5	■	2 1/2" Gas	[m]	189	179	176	172	169	163	156	147	138	132	102	75
E6XD30/21+MCR410	7,5	10	○	2 1/2" Gas	[m]	222	212	209	204	200	193	184	178	167	156	126	89
E6XD30/21+MAC610A	7,5	10	■	2 1/2" Gas	[m]	222	212	209	204	200	193	184	178	167	156	126	89
E6XD30/24+MCR410	7,5	10	○	2 1/2" Gas	[m]	253	236	232	227	222	214	205	197	181	172	138	96
E6XD30/24+MAC610A	7,5	10	■	2 1/2" Gas	[m]	253	236	232	227	222	214	205	197	181	172	138	96
E6XD30/28+MAC612A	9,2	12,5	■	2 1/2" Gas	[m]	295	281	277	271	263	254	247	230	221	202	169	116
E6XD30/31+MAC612A	9,2	12,5	■	2 1/2" Gas	[m]	325	309	304	297	291	280	267	253	238	227	177	131
E6XD30/36+MAC615A	11	15	■	2 1/2" Gas	[m]	378	358	353	345	338	325	311	294	276	263	203	150
E6XDB30/42+MAC617A	13	17,5	■	2 1/2" Gas	[m]	441	420	413	404	393	379	369	345	332	302	253	170
E6XDB30/47+MAC620A	15	20	■	2 1/2" Gas	[m]	489	-	460	446	438	417	405	378	363	331	276	189
E6XDB30/52+MAC625A	18,5	25	■	2 1/2" Gas	[m]	542	-	511	496	486	464	450	428	404	378	308	212
E6XDB30/56+MAC625A	18,5	25	○	2 1/2" Gas	[m]	581	-	545	529	514	497	477	454	420	401	318	219
E6XDB30/60+MAC625A	18,5	25	○	2 1/2" Gas	[m]	621	-	581	561	550	525	510	477	458	417	334	238
E6XDB30/65+MAC630A	22	30	○	2 1/2" Gas	[m]	675	-	633	614	602	573	558	523	503	460	368	259
NPSH					[m]	-	-	-	2	2	2,2	2,2	2,4	2,7	3,1	4,5	-

M.E.I. ≥ 0.40

■ Without conical valve

□ On request

○ Please contact our sales organisation

For motor performances specification see page "motor features"

Temperature monitoring device for submersed electric motors 4" + 6": see page "Accessories"

■ Sans soupape du clapet.

□ Sur demande

○ Contacter notre service commercial.

Pour caractéristiques techniques moteurs voir page "Caractéristiques des moteurs"

Appareillage de contrôle de la température des moteurs électriques immergés 4" + 6": voir page "Accessories"

■ Senza clapet valvola di ritegno

□ Su richiesta

○ Interpellare la sede o la rete di vendita

Per caratteristiche motori vedere pagina caratteristiche motori

Apparecchiatura di controllo temperatura motori elettrici sommersi 4" + 6": vedere pagina accessori

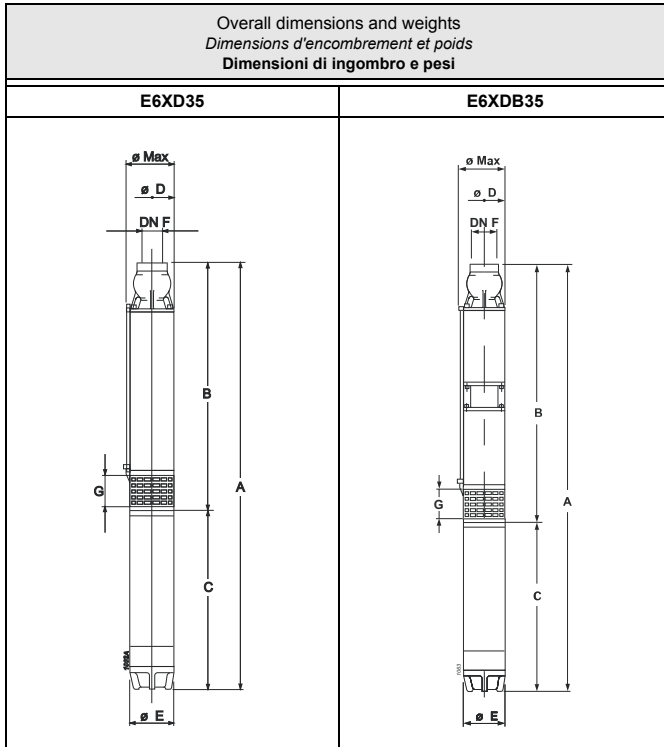

Type Type Tipo	Ø max [mm]	Weight Poids Peso [kg]	A	B	C	D	E	G	F
			[mm]						
E6XD35/3+MCH415	135	19	753	403	350	127	96	-	G2 1/2
E6XD35/4+MCH42	135	20,5	835	438	397	127	96	-	G2 1/2
E6XD35/6+MCH43	135	23,5	945	508	437	127	96	-	G2 1/2
E6XD35/7+MCH44	135	26,5	961	543	418	127	96	-	G2 1/2
E6XD35/9+MCH455	135	31,5	1081	613	468	127	96	-	G2 1/2
E6XD35/9+MAC65A	145	43,5	1178	648	530	141	143	100	G2 1/2
E6XD35/11+MCR475	135	40	1383	683	700	127	96	-	G2 1/2
E6XD35/11+MAC67A	145	47,5	1268	718	550	141	143	100	G2 1/2
E6XD35/13+MCR475	135	40	1512	812	700	127	96	-	G2 1/2
E6XD35/13+MAC67A	145	48,5	1397	847	550	141	143	100	G2 1/2
E6XD35/15+MCR410	135	45,5	1682	882	800	127	96	-	G2 1/2
E6XD35/15+MAC610A	145	55	1512	917	595	141	143	100	G2 1/2
E6XD35/18+MCR410	135	47	1787	987	800	127	96	-	G2 1/2
E6XD35/18+MAC610A	145	57	1617	1022	595	141	143	100	G2 1/2
E6XD35/22+MAC612A	145	63,5	1802	1162	640	141	143	100	G2 1/2
E6XD35/26+MAC615A	145	69	1972	1302	670	141	143	100	G2 1/2
E6XD35/31+MAC617A	145	75,5	2177	1477	700	141	143	100	G2 1/2
E6XD35/35+MAC620A	145	82,5	2332	1617	715	141	143	100	G2 1/2
E6XDB35/40+MAC625A	145	90	2734	1984	750	141	143	100	G2 1/2
E6XDB35/44+MAC625A	145	42	2874	2124	750	141	143	100	G2 1/2
E6XDB35/48+MAC630A	145	99,5	3054	2264	790	141	143	100	G2 1/2
E6XDB35/52+MAC630A	145	102	3194	2404	790	141	143	100	G2 1/2
E6XDB35/56+MAC630A	145	105	3334	2544	790	141	143	100	G2 1/2
E6XDB35/60+MAC635A	145	117,5	3559	2684	875	141	143	100	G2 1/2
E6XDB35/65+MAC635A	145	121	3734	2859	875	141	143	100	G2 1/2

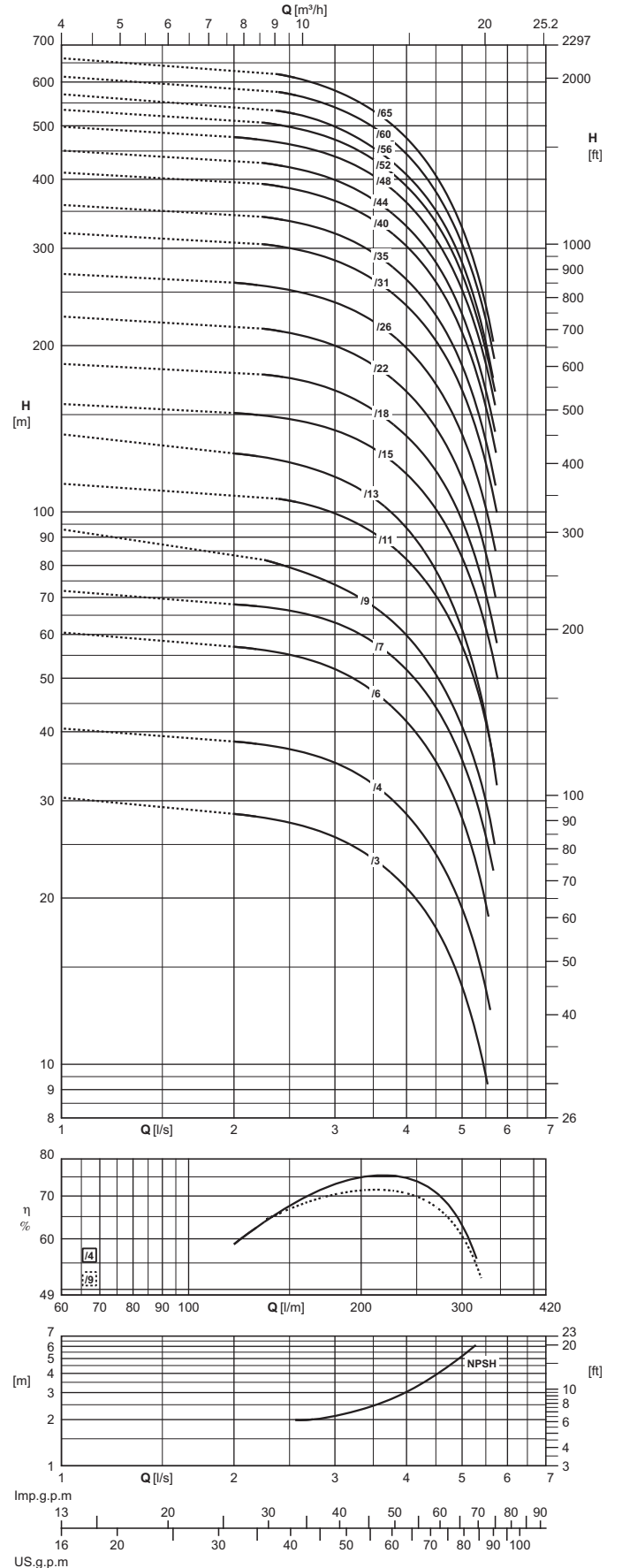

The hydraulic performance characteristics are guaranteed as conforming to standard UNI/ISO 9906 Grade 3B.
The hydraulic characteristics of units coupled to MAC 6../2B 6" motors are guaranteed as conforming to standard UNI/ISO 9906 Grade 2B.

Les caractéristiques hydrauliques de fonctionnement sont garanties conformes à la norme UNI/ISO 9906 Niveau 3B.
Pour les groupes accouplés à des moteurs 6" MAC 6../2B les caractéristiques hydrauliques sont garanties conformes à la norme UNI/ISO 9906 Niveau 2B.

Le caratteristiche idrauliche di funzionamento vengono garantite secondo la norma UNI/ISO 9906 Grado 3B.
Per i gruppi accoppiati a motori 6" MAC 6../2B le caratteristiche idrauliche vengono garantite secondo la norma UNI/ISO 9906 Grado 2B.

Electric pump type Electropompe type Elettropompa tipo	Motor power Puisse. moteur Potenza motore		Horizontal installation Installation horizontale Installazione orizzontale	Check valve \varnothing Clapet de retenue \varnothing Valvola di ritegno \varnothing	Capacity Debit Portata												
	[kW]	[HP]			[l/s]	0	2	2,2	2,4	2,6	2,8	3	3,5	4	4,5	5	5,5
					[l/min]	0	120	132	144	156	168	180	210	240	270	300	330
					[m ³ /h]	0	7,2	7,9	8,6	9,4	10,1	10,8	12,6	14,4	16,2	18	19,8
		Head Hauteur Prevalenza															
E6XD35/3+MCH415	1,1	1,5	■	2 1/2" Gas	[m]	30,5	28,5	28	27,5	27	26,5	25,5	23,5	20,5	17,5	14	9,2
E6XD35/4+MCH42	1,5	2	■	2 1/2" Gas	[m]	40,5	38,5	38	37,5	37	36,5	35	32	28,5	24,5	19	13,5
E6XD35/6+MCH43	2,2	3	■	2 1/2" Gas	[m]	60	57	56	56	55	53	52	47,5	42	35	28	20
E6XD35/7+MCH44	3	4	■	2 1/2" Gas	[m]	72	68	67	67	66	65	63	58	51	44	35,5	26,5
E6XD35/9+MCH455	4	5,5	■	2 1/2" Gas	[m]	93	-	-	80	78	76	74	67	60	50	41,5	29,5
E6XD35/9+MAC65A	4	5,5	■	2 1/2" Gas	[m]	94	90	89	88	87	86	84	78	70	61	50	37,5
E6XD35/11+MCR475	5,5	7,5	○	2 1/2" Gas	[m]	112	-	-	105	104	101	99	91	83	71	57	41
E6XD35/11+MAC67A	5,5	7,5	■	2 1/2" Gas	[m]	115	110	109	108	107	104	102	95	84	74	61	49
E6XD35/13+MCR475	5,5	7,5	○	2 1/2" Gas	[m]	138	127	126	124	122	119	116	106	94	79	63	44
E6XD35/13+MAC67A	5,5	7,5	■	2 1/2" Gas	[m]	135	128	127	126	124	122	119	111	100	83	67	49,5
E6XD35/15+MCR410	7,5	10	○	2 1/2" Gas	[m]	157	151	150	148	146	144	141	130	117	102	83	63
E6XD35/15+MAC610A	7,5	10	■	2 1/2" Gas	[m]	157	151	150	148	146	144	141	130	117	102	83	63
E6XD35/18+MCR410	7,5	10	○	2 1/2" Gas	[m]	185	-	-	175	173	170	166	152	137	120	96	72
E6XD35/18+MAC610A	7,5	10	■	2 1/2" Gas	[m]	185	-	-	175	173	170	166	152	137	120	96	72
E6XD35/22+MAC612A	9,2	12,5	■	2 1/2" Gas	[m]	226	-	-	212	209	205	200	183	166	140	115	82
E6XD35/26+MAC615A	11	15	■	2 1/2" Gas	[m]	270	260	257	254	250	245	240	222	200	167	135	100
E6XD35/31+MAC617A	13	17,5	■	2 1/2" Gas	[m]	320	-	-	302	297	292	286	261	236	207	165	125
E6XD35/35+MAC620A	15	20	■	2 1/2" Gas	[m]	359	-	-	338	333	327	320	293	264	224	185	131
E6XDB35/40+MAC625A	18,5	25	■	2 1/2" Gas	[m]	411	-	-	387	381	375	366	336	303	257	211	149
E6XDB35/44+MAC625A	18,5	25	■	2 1/2" Gas	[m]	451	-	-	423	416	409	400	366	330	280	230	162
E6XDB35/48+MAC630A	22	30	■	2 1/2" Gas	[m]	498	477	472	467	460	451	441	409	368	307	249	183
E6XDB35/52+MAC630A	22	30	■	2 1/2" Gas	[m]	535	-	-	500	493	484	473	432	390	331	272	192
E6XDB35/56+MAC630A	22	30	○	2 1/2" Gas	[m]	570	-	-	532	525	511	499	456	405	357	287	204
E6XDB35/60+MAC635A	26	35	○	2 1/2" Gas	[m]	614	-	-	576	568	552	540	495	450	383	306	220
E6XDB35/65+MAC635A	26	35	○	2 1/2" Gas	[m]	662	-	-	620	611	593	580	532	471	412	331	237
NPSH					[m]	-	-	-	-	2	2	2,2	2,2	2,9	3,8	5	-

M.E.I. \geq 0.40

■ Without conical valve

○ On request

○ Please contact our sales organisation

For motor performances specification see page "motor features"

Temperature monitoring device for submersed electric motors 4" + 6": see page "Accessories"

■ Sans soupape du clapet.

○ Sur demande

○ Contacter notre service commercial.

Pour caractéristiques techniques moteurs voir page "Caractéristiques des moteurs"

Appareillage de contrôle de la température des moteurs électriques immergés 4" + 6": voir page "Accessories"

■ Senza clapet valvola di ritegno

○ Su richiesta

○ Interpellare la sede o la rete di vendita

Per caratteristiche motori vedere pagina caratteristiche motori

Apparecchiatura di controllo temperatura motori elettrici sommersi 4" + 6": vedere pagina accessori

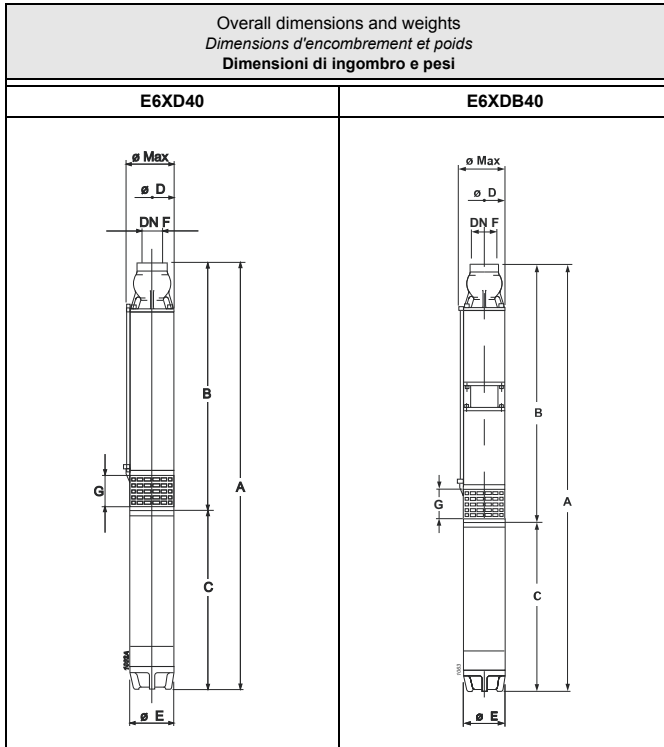

Type Type Tipo	Ø max	Weight Poids Peso	A	B	C	D	E	G	F
	[mm]								
E6XD40/3+MCH42	135	21	815	418	397	127	96	-	G2 1/2
E6XD40/4+MCH43	135	23	895	458	437	127	96	-	G2 1/2
E6XD40/6+MCH44	135	27	956	538	418	127	96	-	G2 1/2
E6XD40/8+MCH455	135	32	1086	618	468	127	96	-	G2 1/2
E6XD40/8+MAC65A	145	44	1183	653	530	141	143	100	G2 1/2
E6XD40/10+MCR475	135	39,5	1398	698	700	127	96	-	G2 1/2
E6XD40/10+MAC67A	145	48	1283	733	550	141	143	100	G2 1/2
E6XD40/13+MCR410	135	45,5	1677	877	800	127	96	-	G2 1/2
E6XD40/13+MAC610A	145	55	1507	912	595	141	143	100	G2 1/2
E6XD40/16+MAC612A	145	60,5	1672	1032	640	141	143	100	G2 1/2
E6XD40/20+MAC615A	145	66	1862	1192	670	141	143	100	G2 1/2
E6XD40/23+MAC617A	145	71,5	2012	1312	700	141	143	100	G2 1/2
E6XD40/26+MAC620A	145	77,5	2147	1432	715	141	143	100	G2 1/2
E6XD40/30+MAC625A	145	84,5	2342	1592	750	141	143	100	G2 1/2
E6XD40/33+MAC625A	145	86,5	2462	1712	750	141	143	100	G2 1/2
E6XDB40/38+MAC630A	145	93,5	2894	2104	790	141	143	100	G2 1/2
E6XDB40/42+MAC630A	145	96,5	3054	2264	790	141	143	100	G2 1/2
E6XDB40/44+MAC635A	145	108	3219	2344	875	141	143	100	G2 1/2
E6XDB40/48+MAC635A	145	110,5	3379	2504	875	141	143	100	G2 1/2
E6XDB40/51+MAC640A	145	128,5	3649	2624	1025	141	143	100	G2 1/2
E6XDB40/55+MAC640A	145	131,2	3809	2784	1025	141	143	100	G2 1/2
E6XDB40/60+MAC650B	145	160	4211	2984	1227	141	143	100	G2 1/2

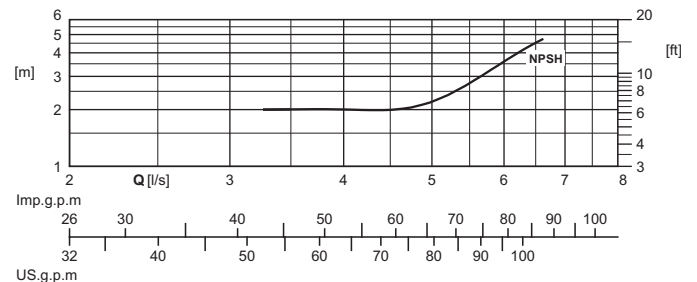
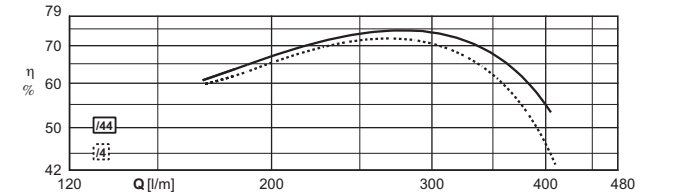
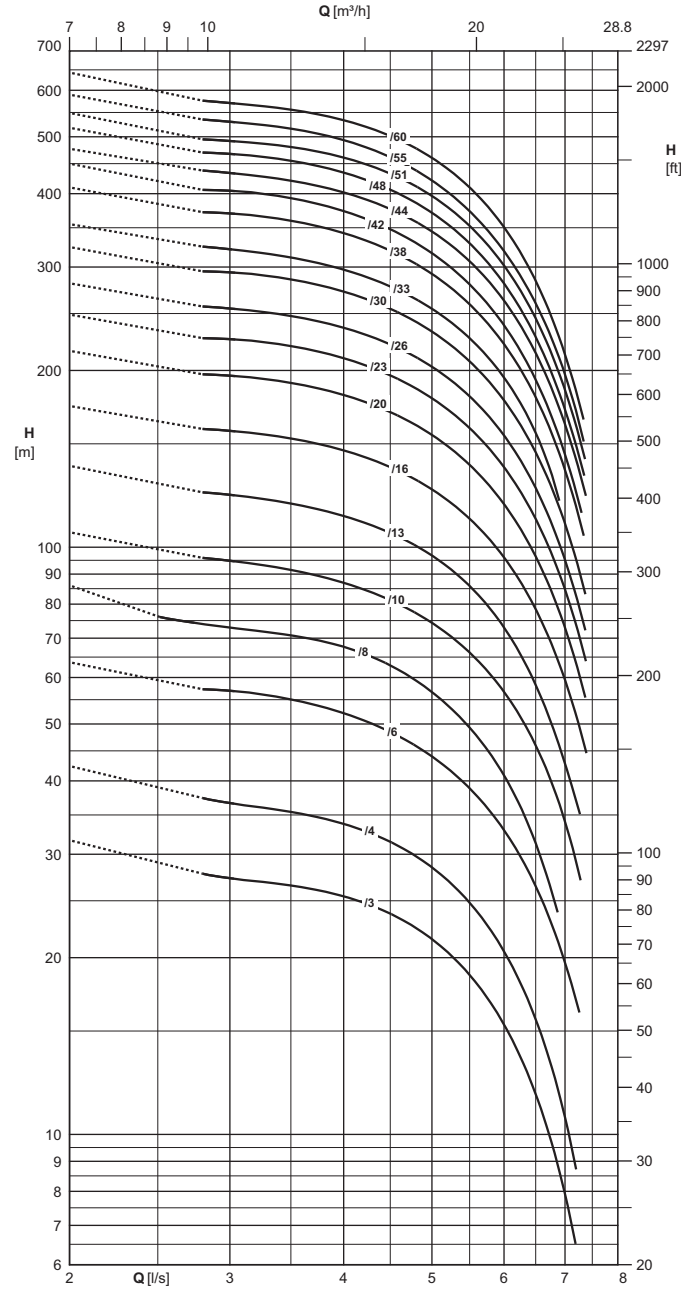

The hydraulic performance characteristics are guaranteed as conforming to standard UNI/ISO 9906 Grade 3B.
The hydraulic characteristics of units coupled to MAC 6../2B 6" motors are guaranteed as conforming to standard UNI/ISO 9906 Grade 2B.

Les caractéristiques hydrauliques de fonctionnement sont garanties conformes à la norme UNI/ISO 9906 Niveau 3B.
Pour les groupes accouplés à des moteurs 6" MAC 6../2B les caractéristiques hydrauliques sont garanties conformes à la norme UNI/ISO 9906 Niveau 2B.

Le caratteristiche idrauliche di funzionamento vengono garantite secondo la norma UNI/ISO 9906 Grado 3B.
Per i gruppi accoppiati a motori 6" MAC 6../2B le caratteristiche idrauliche vengono garantite secondo la norma UNI/ISO 9906 Grado 2B.

Electric pump type Electropompe type Elettropompa tipo	Motor power Puis. moteur Potenza motore		Horizontal installation Installation horizontale Installazione orizzontale	Check valve \varnothing Clapet de retenue \varnothing Valvola di ritegno \varnothing	Capacity Debit Portata												
	[kW]	[HP]			[l/s]	0	2,6	2,8	3	3,5	4	4,5	5	5,5	6	6,5	7
					[l/min]	0	156	168	180	210	240	270	300	330	360	390	420
					[m ³ /h]	0	9,4	10,1	10,8	12,6	14,4	16,2	18	19,8	21,6	23,4	25,2
		Head Hauteur Prevalenza															
		[m]	31,5	-	28	27,5	26,5	25,5	23,5	21,5	18,5	15	11,5	8,2			
E6XD40/3+MCH42	1,5	2	■	2 1/2" Gas	[m]	31,5	-	28	27,5	26,5	25,5	23,5	21,5	18,5	15	11,5	8,2
E6XD40/4+MCH43	2,2	3	■	2 1/2" Gas	[m]	42,5	-	37,5	36,5	35,5	34	31,5	28,5	25	20	15,5	11
E6XD40/6+MCH44	3	4	■	2 1/2" Gas	[m]	64	-	57	57	55	52	48,5	43,5	39	33,5	27	19,5
E6XD40/8+MCH455	4	5,5	■	2 1/2" Gas	[m]	86	75	74	73	71	67	63	56	49,5	41,5	31	-
E6XD40/8+MAC65A	4	5,5	■	2 1/2" Gas	[m]	87	-	78	78	76	71	66	60	52	45	37	28,5
E6XD40/10+MCR475	5,5	7,5	○	2 1/2" Gas	[m]	106	-	96	94	91	87	82	74	66	57	46	33
E6XD40/10+MAC67A	5,5	7,5	■	2 1/2" Gas	[m]	108	-	98	97	95	90	85	78	68	59	47,5	36,5
E6XD40/13+MCR410	7,5	10	○	2 1/2" Gas	[m]	137	-	124	122	118	113	105	97	86	73	59	42
E6XD40/13+MAC610A	7,5	10	■	2 1/2" Gas	[m]	141	-	130	128	124	119	111	102	92	80	64	49
E6XD40/16+MAC612A	9,2	12,5	■	2 1/2" Gas	[m]	174	-	159	157	153	146	137	126	113	95	78	58
E6XD40/20+MAC615A	11	15	■	2 1/2" Gas	[m]	216	-	197	195	190	181	170	156	137	118	95	72
E6XD40/23+MAC617A	13	17,5	■	2 1/2" Gas	[m]	249	-	227	226	219	210	196	180	161	136	112	84
E6XD40/26+MAC620A	15	20	■	2 1/2" Gas	[m]	281	-	257	254	247	236	222	204	179	154	124	94
E6XD40/30+MAC625A	18,5	25	■	2 1/2" Gas	[m]	324	-	295	293	285	272	255	234	206	177	143	109
E6XD40/33+MAC625A	18,5	25	■	2 1/2" Gas	[m]	355	-	325	321	311	297	277	257	227	192	159	-
E6XDB40/38+MAC630A	22	30	■	2 1/2" Gas	[m]	410	-	372	370	359	343	321	295	258	219	180	137
E6XDB40/42+MAC630A	22	30	■	2 1/2" Gas	[m]	450	-	406	404	393	374	350	316	278	239	195	145
E6XDB40/44+MAC635A	26	35	○	2 1/2" Gas	[m]	477	-	438	433	420	402	377	347	311	261	214	160
E6XDB40/48+MAC635A	26	35	○	2 1/2" Gas	[m]	518	-	470	467	454	435	408	374	328	282	226	173
E6XDB40/51+MAC640A	30	40	○	2 1/2" Gas	[m]	549	-	495	491	480	461	434	399	350	301	242	185
E6XDB40/55+MAC640A	30	40	○	2 1/2" Gas	[m]	590	-	535	529	515	494	464	426	372	316	260	199
E6XDB40/60+MAC650B	37	50	○	2 1/2" Gas	[m]	643	-	576	570	555	534	504	457	409	347	284	216
NPSH					[m]	-	-	-	-	2	2	2,1	2,4	2,7	3,5	4,5	-

M.E.I. \geq 0.40

■ Without conical valve

□ On request

○ Please contact our sales organisation

For motor performances specification see page "motor features"

Temperature monitoring device for submersed electric motors 4" + 6": see page "Accessories"

■ Sans soupape du clapet.

□ Sur demande

○ Contacter notre service commercial.

Pour caractéristiques techniques moteurs voir page "Caractéristiques des moteurs"

Appareillage de contrôle de la température des moteurs électriques immergés 4" + 6": voir page "Accessories"

■ Senza clapet valvola di ritegno

□ Su richiesta

○ Interpellare la sede o la rete di vendita

Per caratteristiche motori vedere pagina caratteristiche motori

Apparecchiatura di controllo temperatura motori elettrici sommersi 4" + 6": vedere pagina accessori

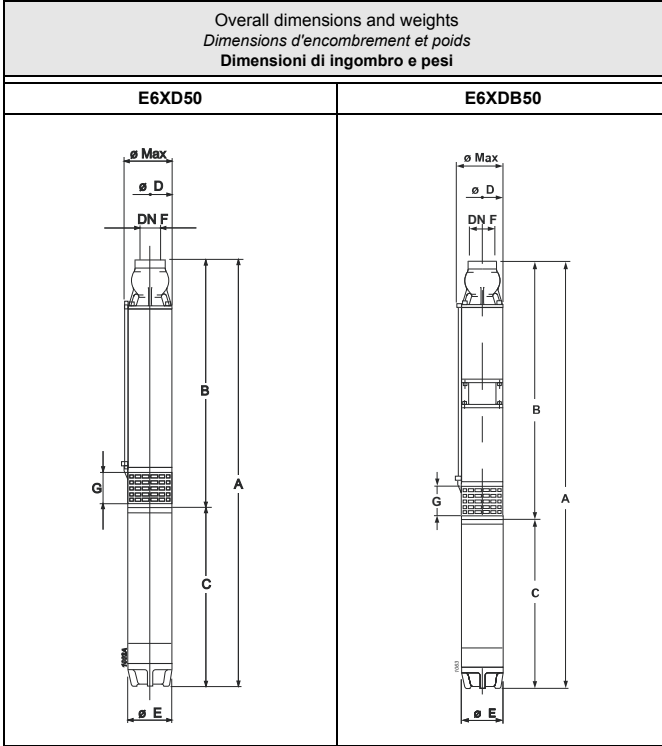

Type Type Tipo	Ø max [mm]	Weight Poids Peso [kg]	A	B	C	D	E	G	F
			[mm]						
E6XD50/3+MCH43	135	20,5	885	448	437	127	96	-	G2 1/2
E6XD50/4+MCH44	135	24	916	498	418	127	96	-	G2 1/2
E6XD50/5+MCH455	135	28	1016	548	468	127	96	-	G2 1/2
E6XD50/5+MAC65A	145	40,5	1113	583	530	141	143	100	G2 1/2
E6XD50/7+MCR475	135	36	1348	648	700	127	96	-	G2 1/2
E6XD50/7+MAC67A	145	44,5	1233	683	550	141	143	100	G2 1/2
E6XD50/10+MCR410	135	42,5	1657	857	800	127	96	-	G2 1/2
E6XD50/10+MAC610A	145	52	1487	892	595	141	143	100	G2 1/2
E6XD50/12+MAC612A	145	57,5	1632	992	640	141	143	100	G2 1/2
E6XD50/15+MAC615A	145	62,5	1812	1142	670	141	143	100	G2 1/2
E6XD50/17+MAC617A	145	67,5	1942	1242	700	141	143	100	G2 1/2
E6XD50/20+MAC620A	145	74,5	2107	1392	715	141	143	100	G2 1/2
E6XD50/25+MAC625A	145	83	2392	1642	750	141	143	100	G2 1/2
E6XDB50/30+MAC630A	145	91	2874	2084	790	141	143	100	G2 1/2
E6XDB50/35+MAC635A	145	105,5	3209	2334	875	141	143	100	G2 1/2
E6XDB50/40+MAC640A	145	125	3609	2584	1025	141	143	100	G2 1/2
E6XDB50/45+MAC650B	145	155	4061	2834	1227	141	143	100	G2 1/2
E6XDB50/48+MAC650B	145	157,5	4211	2984	1227	141	143	100	G2 1/2

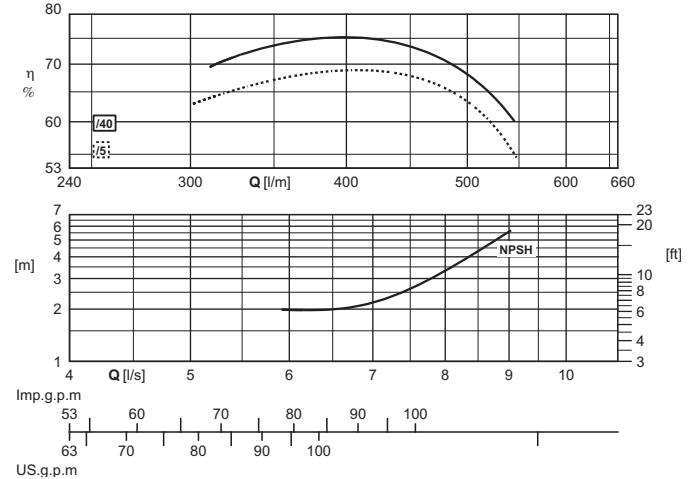
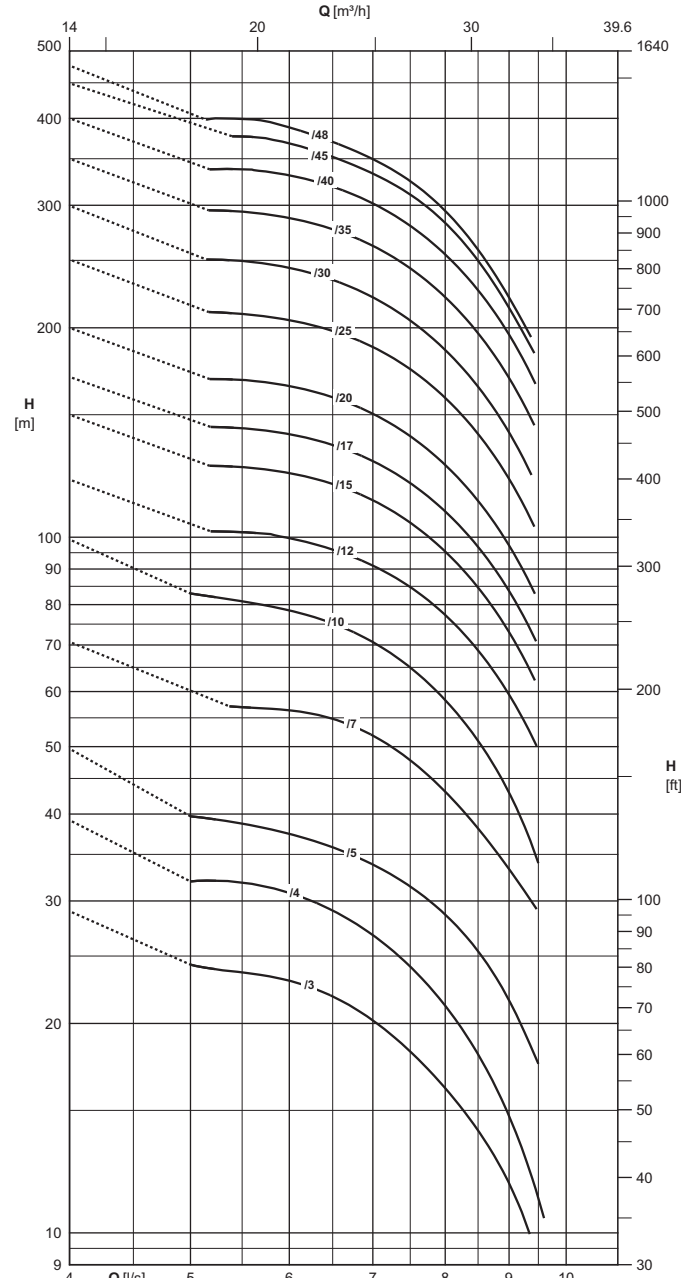

The hydraulic performance characteristics are guaranteed as conforming to standard UNI/ISO 9906 Grade 3B.
The hydraulic characteristics of units coupled to MAC 6../2B 6" motors are guaranteed as conforming to standard UNI/ISO 9906 Grade 2B.

Les caractéristiques hydrauliques de fonctionnement sont garanties conformes à la norme UNI/ISO 9906 Niveau 3B.
Pour les groupes accouplés à des moteurs 6" MAC 6../2B les caractéristiques hydrauliques sont garanties conformes à la norme UNI/ISO 9906 Niveau 2B.

Le caratteristiche idrauliche di funzionamento vengono garantite secondo la norma UNI/ISO 9906 Grado 3B.
Per i gruppi accoppiati a motori 6" MAC 6../2B le caratteristiche idrauliche vengono garantite secondo la norma UNI/ISO 9906 Grado 2B.

Electric pump type Electropompe type Elettropompa tipo	Motor power Puis. moteur Potenza motore		Horizontal installation Installation horizontale Installazione orizzontale	Check valve Ø Clapet de retenue Ø Valvola di ritegno Ø	Capacity Débit Portata											
	[kW]	[HP]			[l/s]	0	5	5,5	6	6,5	7	7,5	8	8,5	9	9,5
					[l/min]	0	300	330	360	390	420	450	480	510	540	570
					[m³/h]	0	18	19,8	21,6	23,4	25,2	27	28,8	30,6	32,4	34,2
Head Hauteur Prevalenza																
		[m]	29	24,5	23,5	23	22	20,5	18	16	14	11,5	-			
E6XD50/3+MCH43	2,2	3	■	2 1/2" Gas	[m]	29	24,5	23,5	23	22	20,5	18	16	14	11,5	-
E6XD50/4+MCH44	3	4	■	2 1/2" Gas	[m]	39	32	32	31	29	26,5	24	21	18	15	11,5
E6XD50/5+MCH455	4	5,5	■	2 1/2" Gas	[m]	49,5	39,5	39	37,5	36	34	31,5	28,5	25,5	21,5	17,5
E6XD50/5+MAC65A	4	5,5	■	2 1/2" Gas	[m]	51	43,5	42	40,5	38,5	36,5	34	30,5	27	23,5	20
E6XD50/7+MCR475	5,5	7,5	○	2 1/2" Gas	[m]	71	-	57	56	55	52	47,5	43,5	38	33	29
E6XD50/7+MAC67A	5,5	7,5	■	2 1/2" Gas	[m]	70	-	59	58	56	53	49,5	45	40	34,5	29
E6XD50/10+MCR410	7,5	10	○	2 1/2" Gas	[m]	99	83	81	78	75	70	65	58	51	42,5	34
E6XD50/10+MAC610A	7,5	10	■	2 1/2" Gas	[m]	101	-	84	83	80	76	72	64	58	49	42
E6XD50/12+MAC612A	9,2	12,5	■	2 1/2" Gas	[m]	121	-	102	100	95	91	84	77	69	59	50
E6XD50/15+MAC615A	11	15	■	2 1/2" Gas	[m]	150	-	126	124	119	113	104	96	84	73	-
E6XD50/17+MAC617A	13	17,5	■	2 1/2" Gas	[m]	170	-	143	141	135	129	119	109	97	83	71
E6XD50/20+MAC620A	15	20	■	2 1/2" Gas	[m]	200	-	168	165	158	151	139	127	111	97	-
E6XD50/25+MAC625A	18,5	25	■	2 1/2" Gas	[m]	251	-	209	205	197	188	173	159	139	122	-
E6XDB50/30+MAC630A	22	30	■	2 1/2" Gas	[m]	299	-	249	243	235	221	205	184	165	141	-
E6XDB50/35+MAC635A	26	35	○	2 1/2" Gas	[m]	350	-	293	288	277	263	242	222	195	170	-
E6XDB50/40+MAC640A	30	40	○	2 1/2" Gas	[m]	400	-	337	332	318	303	280	255	228	195	166
E6XDB50/45+MAC650B	37	50	○	2 1/2" Gas	[m]	449	-	376	367	353	333	310	282	251	213	-
E6XDB50/48+MAC650B	37	50	○	2 1/2" Gas	[m]	476	-	399	387	371	348	326	292	260	221	-
NPSH					[m]	-	-	-	2	2,1	2,2	2,6	3,2	4,1	5,5	-

M.E.I. ≥ 0,40

■ Without conical valve

□ On request

○ Please contact our sales organisation

For motor performances specification see page "motor features"

■ Sans soupape du clapet.

□ Sur demande

○ Contacter notre service commercial.

Pour caractéristiques techniques moteurs voir page "Caractéristiques des moteurs"

■ Senza clapet valvola di ritegno

□ Su richiesta

○ Interpellare la sede o la rete di vendita

Per caratteristiche motori vedere pagina caratteristiche motori

Temperature monitoring device for submersed electric motors 4" + 6": Appareillage de contrôle de la température des moteurs électriques immergés 4" + 6": voir page "Accessories"

Apparecchiatura di controllo temperatura motori elettrici sommersi 4" + 6": vedere pagina accessori

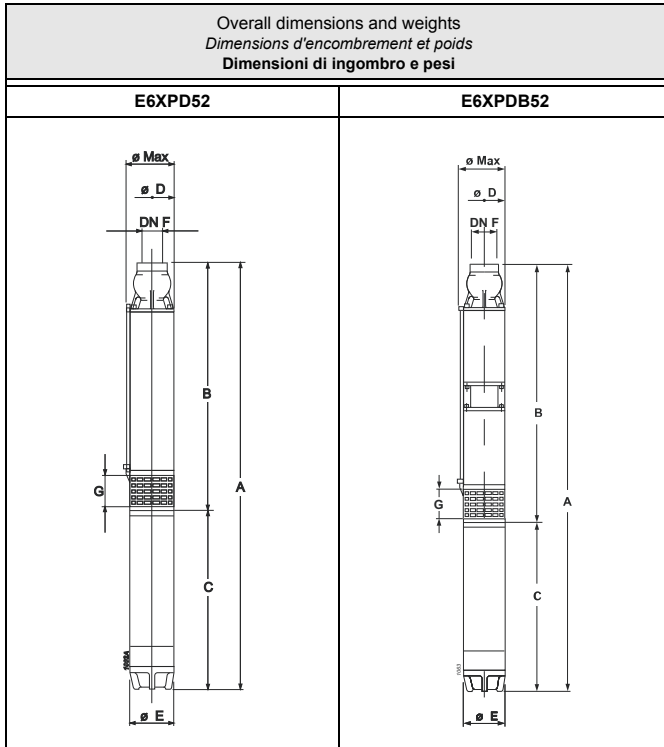

Type Type Tipo	Ø max [mm]	Weight Poids Peso [kg]	A	B	C	D	E	G	F
			[mm]						
E6XPD52/2AB+MCH43	135	21,5	921	484	437	127	96	-	G3
E6XPD52/3B+MCH44	135	25	962	544	418	127	96	-	G3
E6XPD52/3A+MCH455	135	28,5	1012	544	468	127	96	-	G3
E6XPD52/3A+MAC65A	145	40,5	1074	544	530	141	143	100	G3
E6XPD52/4A+MCR475	135	35,5	1304	604	700	127	96	-	G3
E6XPD52/4A+MAC67A	145	44	1154	604	550	141	143	100	G3
E6XPD52/6K+MCR410	135	42	1524	724	800	127	96	-	G3
E6XPD52/6K+MAC610A	145	51,5	1319	724	595	141	143	100	G3
E6XPD52/7A+MAC612A	145	56,5	1424	784	640	141	143	100	G3
E6XPD52/9K+MAC615A	145	61,5	1633	963	670	141	143	100	G3
E6XPD52/10I+MAC617A	145	66	1723	1023	700	141	143	100	G3
E6XPD52/12K+MAC620A	145	72,5	1858	1143	715	141	143	100	G3
E6XPD52/14A+MAC625A	145	78,5	2013	1263	750	141	143	100	G3
E6XPDB52/17A+MAC630A	145	86	2440	1650	790	141	143	100	G3
E6XPDB52/19A+MAC635A	145	98,5	2645	1770	875	141	143	100	G3
E6XPDB52/22A+MAC640A	145	117,5	2975	1950	1025	141	143	100	G3
E6XPDB52/25A+MAC650B	145	146,5	3357	2130	1227	141	143	100	G3
E6XPDB52/28A+MAC650B	145	150	3537	2310	1227	141	143	100	G3

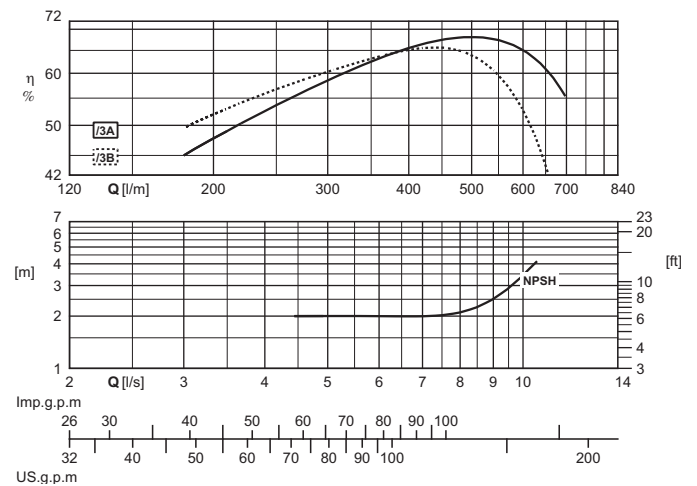
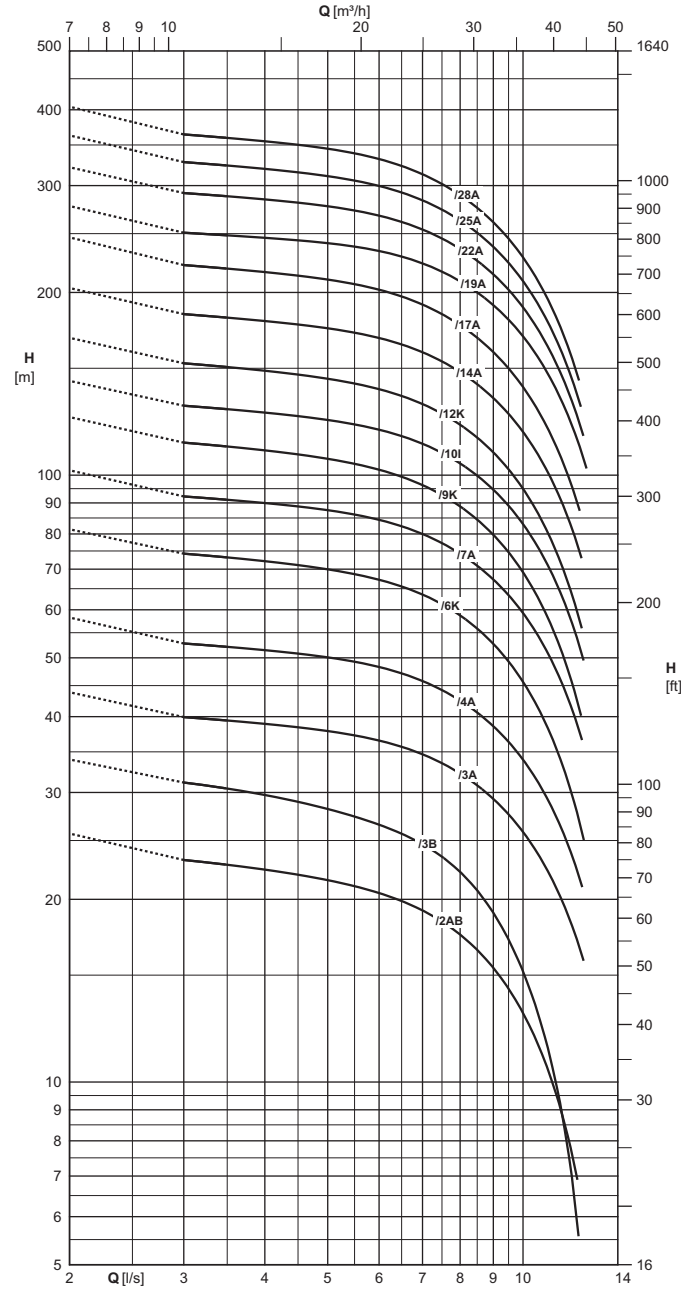

The hydraulic performance characteristics are guaranteed as conforming to standard UNI/ISO 9906 Grade 3B.
The hydraulic characteristics of units coupled to MAC 6.. /2B 6" motors are guaranteed as conforming to standard UNI/ISO 9906 Grade 2B.

Les caractéristiques hydrauliques de fonctionnement sont garanties conformes à la norme UNI/ISO 9906 Niveau 3B.
Pour les groupes accouplés à des moteurs 6" MAC 6.. /2B les caractéristiques hydrauliques de fonctionnement sont garanties conformes à la norme UNI/ISO 9906 Niveau 2B.

Le caratteristiche idrauliche di funzionamento vengono garantite secondo la norma UNI/ISO 9906 Grado 3B.
Per i gruppi accoppiati a motori 6" MAC 6.. /2B le caratteristiche idrauliche vengono garantite secondo la norma UNI/ISO 9906 Grado 2B.

Electric pump type Electropompe type Elettropompa tipo	Motor power Puis. moteur Potenza motore		Horizontal installation Installation horizontale Installazione orizzontale	Check valve \varnothing Clapet de retenue \varnothing Valvola di ritegno \varnothing	Capacity Debit Portata																		
	[kW]	[HP]			[l/s]	0	3	3,5	4	4,5	5	5,5	6	6,5	7	7,5	8	8,5	9	9,5	10	11	12
					[l/min]	0	180	210	240	270	300	330	360	390	420	450	480	510	540	570	600	660	720
					[m ³ /h]	0	10,8	12,6	14,4	16,2	18	19,8	21,6	23,4	25,2	27	28,8	30,6	32,4	34,2	36	39,6	43,2
Head Hauteur Prevalenza																							
E6XPD52/2AB+MCH43	2,2	3	■	3" Gas	[m]	25,5	23	23	22,5	22	21,5	21	20,5	20	19	18,5	17,5	16,5	15,5	14	13	10,5	7,2
E6XPD52/3B+MCH44	3	4	■	3" Gas	[m]	34	31	30,5	30	29	28	27,5	26,5	25,5	24,5	23,5	22	20,5	19	17	15	11	6,5
E6XPD52/3A+MCH455	4	5,5	■	3" Gas	[m]	44	40	39,5	39	38,5	38	37,5	36,5	36	35	33,5	32	30,5	29	27,5	25,5	22	17,5
E6XPD52/3A+MAC65A	4	5,5	■	3" Gas	[m]	44	40	39,5	39	38,5	38	37,5	36,5	35,5	35	33,5	32	30,5	29	27,5	25,5	22	17,5
E6XPD52/4A+MCR475	5,5	7,5	○	3" Gas	[m]	57	52	51	50	49,5	48,5	47,5	46	45	43	41,5	39,5	37,5	35	32,5	29,5	24	17,5
E6XPD52/4A+MAC67A	5,5	7,5	■	3" Gas	[m]	58	53	52	51	51	50	49,5	48	47	45,5	44	42,5	40,5	38,5	36,5	34	29	22,5
E6XPD52/6K+MCR410	7,5	10	○	3" Gas	[m]	81	74	73	72	71	70	69	67	66	64	61	59	56	52	49	45,5	37,5	28,5
E6XPD52/6K+MAC610A	7,5	10	■	3" Gas	[m]	81	74	73	72	71	70	69	67	66	64	61	59	56	52	49	45,5	37,5	28,5
E6XPD52/7A+MAC612A	9,2	12,5	■	3" Gas	[m]	102	92	91	90	89	87	86	84	82	80	77	74	71	67	63	59	50	39,5
E6XPD52/9K+MAC615A	11	15	■	3" Gas	[m]	124	113	111	110	108	106	104	102	99	96	93	89	84	80	75	69	57	44
E6XPD52/10I+MAC617A	13	17,5	■	3" Gas	[m]	143	130	128	127	125	123	121	119	116	113	109	104	99	94	89	83	70	55
E6XPD52/12K+MAC620A	15	20	■	3" Gas	[m]	168	153	151	149	146	144	142	138	135	131	126	121	115	109	102	95	78	61
E6XPD52/14A+MAC625A	18,5	25	■	3" Gas	[m]	203	184	182	179	177	175	172	168	164	159	154	148	141	134	126	118	99	79
E6XPDB52/17A+MAC630A	22	30	■	3" Gas	[m]	246	222	219	216	213	210	206	202	197	191	184	177	168	159	150	140	118	92
E6XPDB52/19A+MAC635A	26	35	○	3" Gas	[m]	278	251	248	246	244	241	238	234	229	223	216	208	200	190	180	169	144	117
E6XPDB52/22A+MAC640A	30	40	○	3" Gas	[m]	322	292	288	285	281	278	273	268	262	254	244	235	225	213	201	188	160	129
E6XPDB52/25A+MAC650B	37	50	○	3" Gas	[m]	363	328	324	320	316	311	305	299	292	283	274	263	251	238	222	208	175	140
E6XPDB52/28A+MAC650B	37	50	○	3" Gas	[m]	405	364	360	355	351	345	339	332	323	314	302	288	275	261	245	229	190	151
NPSH					[m]	-	-	-	2	2	2	2	2	2	2	2,1	2,3	2,5	2,9	3,5	5,1	-	-

■ Without conical valve

○ On request

○ Please contact our sales organisation

For motor performances specification see page "motor features"

■ Sans soupape du clapet.

○ Sur demande

○ Contacter notre service commercial.

Pour caractéristiques techniques moteurs voir page "Caractéristiques des moteurs"

■ Senza clapet valvola di ritegno

○ Su richiesta

○ Interpellare la sede o la rete di vendita

Per caratteristiche motori vedere pagina caratteristiche motori

Temperature monitoring device for submersed electric motors 4" + 6": see page "Accessories"

Appareillage de contrôle de la température des moteurs électriques immergés 4" + 6": voir page "Accessories"

Apparecchiatura di controllo temperatura motori elettrici sommersi 4" + 6": vedere pagina accessori

Friction losses
Pertes de charge
Perdite di carico

In feet every 100 feet of straight pipeline
En mètres pour 100 mètres de tuyauterie droite
In metri ogni 100 metri di tubazione diritta

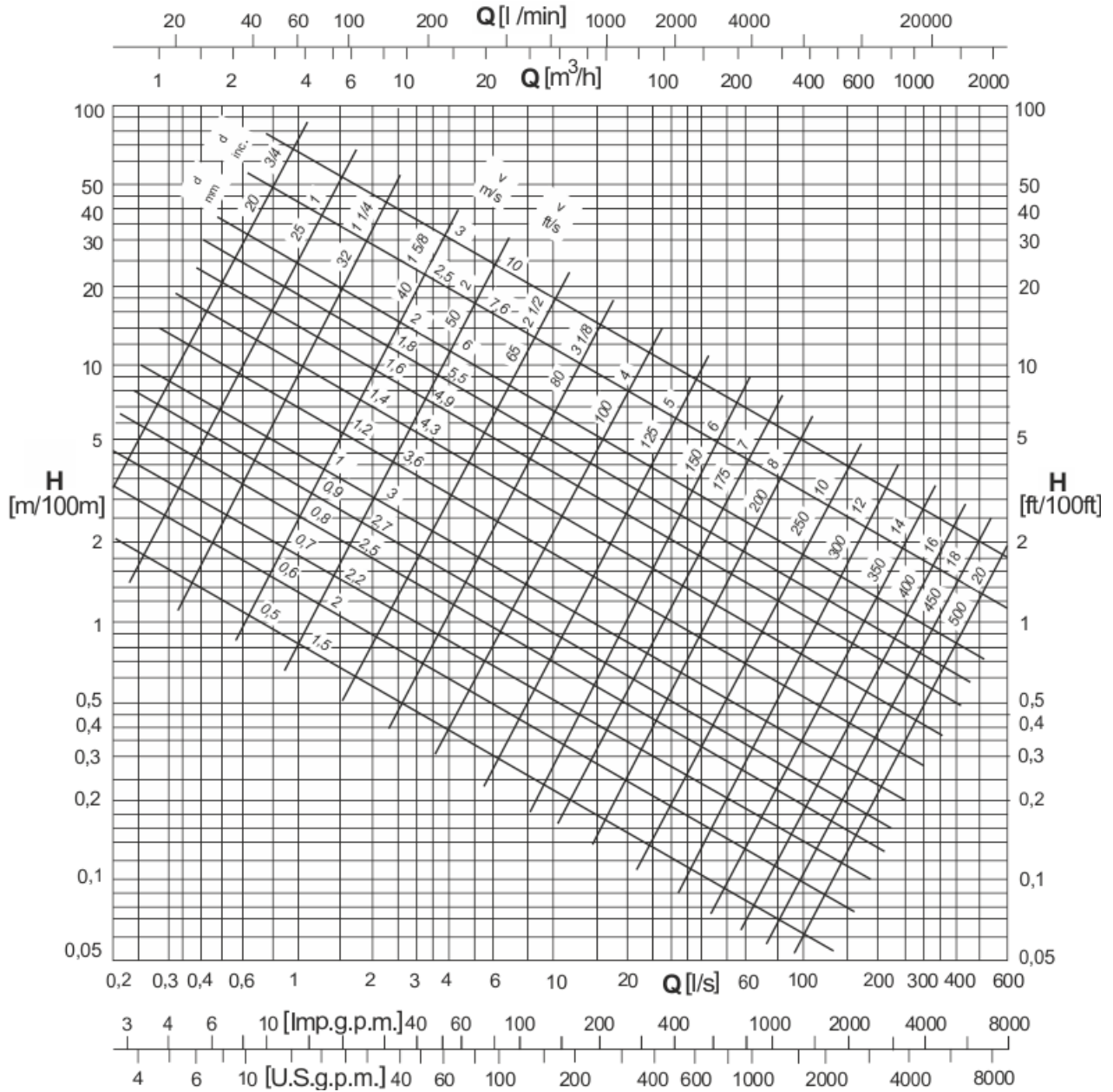

Notes: Above mentioned values are to be intended for internally smooth cast iron pipes. For an estimated evaluation, friction losses must be multiplied for:
0,8 for new rolled steel pipes
1,25 for slightly rusted steel pipes
0,7 for aluminium pipes
0,65 for PVC pipes
1,25 for asbestos cement pipes

Q = Capacity
v = Velocity of water
d = Diameter of pipe
h = Friction loss

Notes: Les valeurs doivent s'entendre pour tuyaux en fonte, lisses à l'intérieur. Pour une évaluation approximative, les pertes de charge doivent être multipliées par:
0,8 pour tuyaux laminés nouveaux en acier
1,25 pour tuyaux légèrement rouillés en acier
0,7 pour tuyaux en aluminium
0,65 pour tuyaux en PVC
1,25 pour tuyaux en fibro-ciment

Q = Débit
v = Vitesse de l'eau
d = Diamètre du tuyau
h = Perte de charge

Note: I valori sopra indicati s'intendono per tubi lisci in ghisa. Per una valutazione di massima, le perdite di carico devono essere moltiplicate per:
0,8 per tubi di acciaio laminati nuovi
1,25 per tubi di acciaio leggermente arrugginiti
0,7 per tubi di alluminio
0,65 per tubi in PVC
1,25 per tubi in fibra-cemento

Q = portata
v = velocità dell'acqua
d = diametro del tubo
h = perdita di carico

Single-phase motors 4" 2 Poles / 50 Hz Moteurs monophasés 4" à 2 Pôles / 50 Hz Motori monofase 4" a 2 Poli / 50 Hz																	
Motor type Moteur type Motore tipo	Motor power Puiss. moteur Potenza motore		Max water temperature Temperature max eau Temperatura max acqua	Min. cooling speed Min. vitesse de refroidissement Min. velocità di raffreddamento	Starts / hour max Max démarrages / heure Max avviamenti/ora	Run capacitor (*) Capacité de marche (*) Capacità di marcia (*)	Capacity of starter (**) Capacité de démarrage (**) Capacità di avviamento (**)	Revolutions per minute Tours minute Giri al minuto	Efficiency Rendement Rendimento		Power factor Facteur de puissance Fattore di potenza		Nominal current Intensité nominale Corrente nominale		Starting Démarrage Avviamento		
	[kW]	[HP]	[°C]	[m/s]	[No.]	[µF]	[µF]	[n ⁻¹]	3/4	4/4	3/4	4/4	Fully loaded A pleine charge A pieno carico	Not loaded A vide A vuoto	Ma Mn	la In	
																	Direct Direct Diretto
					(1)			220 230 240	220 230 240	220 230 240	220 230 240	220 230 240	220 230 240	220 230 240	220 230 240	220 230 240	
MC405M	0,37	0,5	35	0,08	20	20	30	2830 2840 2820	47,0 44,5 42,0	53,0 51,0 49,5	0,990 0,970 0,930	0,990 0,990 0,955	3,2 3,2 3,3	1,9 2,2 2,6	1	3,2	
MC4075M	0,55	0,75	35	0,08	20	25	30	2815 2820 2855	53,5 51,0 48,5	59,5 58,0 55,5	0,985 0,955 0,920	0,990 0,980 0,960	4,2 4,2 4,3	2,3 2,8 3,5	0,87	3,28	
MC41M	0,75	1	35	0,08	20	35	40	2820 2830 2860	57,0 54,5 51,0	63,5 61,5 58,0	0,975 0,940 0,895	0,980 0,970 0,940	5,4 5,5 5,8	3,1 3,9 4,8	1	3,36	
MCH415M	1,1	1,5	35	0,08	20	40	40	2845 2870 2820	59,0 53,5 42,0	63,0 60,0 49,5	0,960 0,910 0,930	0,975 0,950 0,955	8,0 8,1 3,3	4,3 5,4 2,6	0,8	3,3	
MCH42M	1,5	2	35	0,08	20	60	60	2850 2860 2870	56,5 57,0 55,0	65,0 64,0 61,5	0,980 0,930 0,900	0,990 0,950 0,940	10,6 10,8 10,8	6,8 8,6 8,8	0,85	3,24	
MCH43M	2,2	3	35	0,08	15	80	60	2815 2820 2835	67,5 64,5 62,0	71,5 70,0 68,5	0,960 0,950 0,950	0,970 0,960 0,960	14,4 14,2 13,9	6,8 8,6 9,0	0,75	3,38	
MCK42M	1,5	2	35	0,08	20	60	60	2850 2860 2870	56,5 57,0 55,0	65,0 64,0 61,5	0,980 0,930 0,900	0,990 0,950 0,940	10,6 10,8 10,8	6,8 8,6 8,8	0,85	3,24	
MCK43M	2,2	3	35	0,08	15	80	60	2815 2820 2835	67,5 64,5 62,0	71,5 70,0 68,5	0,960 0,950 0,950	0,970 0,960 0,960	14,4 14,2 13,9	6,8 8,6 9,0	0,75	3,38	
MCK455M	4	5,5	35	0,08	15	130	150	2860 2880 -	71,0 69,0 -	72,0 72,0 -	0,980 0,970 -	0,990 0,980 -	25,5 24,3 -	8,6 11,6 -	0,7	4,3	
MCHT43M	2,2	3	35	0,08	15	80	60	2800 2810 -	64,5 62,5 -	68,0 67,5 -	0,960 0,950 -	0,950 0,950 -	15,5 15 -	7,3 9,4 -	0,75	3,4	
MCKT44M	3	4	35	0,08	15	80	100	2870 2880 -	63,5 59,5 -	68,0 65,5 -	0,895 0,835 -	0,900 0,900 -	23,0 22,4 -	17,9 22,0 -	0,5	5,5	
MCKT455M	4	5,5	35	0,08	10	100	150	2840 2860 -	70,5 66,5 -	72,0 70,0 -	0,885 0,825 -	0,900 0,900 -	28,5 27,8 -	21,8 22,4 -	0,5	5,5	

Ma = Starting torque

Mn = Nominal couple

la = Starting current

In = Nominal current

Direction of rotation = Left (anti-clockwise) viewed from shaft projection side

(1) = Equally distributed

To supply voltages and admitted variations see the chapter: Motor general notes

(**) Capacity of starter capacitor with circuit breaker

(*) Run capacitor

Ma = Couple au démarrage

Mn = Couple nominale

la = Intensité au démarrage

In = Intensité nominale

Sens de rotation = Gauche (antioraire) vu du côté bout d'arbre

(1) = Uniformement repartis

Pour les tensions d'alimentation et les variations admises voir le chapitre: Remarques générales moteur

(**) Capacité du condensateur de démarrage avec disjoncteur

(*) Capacité du condensateur de marche

Ma = Coppia di avviamento

Mn = Coppia nominale

la = Corrente di avviamento

In = Corrente nominale

Senso di rotazione = Sinistro (antiorario) visto lato sporgenza albero

(1) = Equipamento ripartiti

Per le tensioni di alimentazione e le variazioni ammesse vedere il capitolo: Note generali motore

(**) Capacità condensatore di avviamento con disgiuntore

(*) Capacità condensatore di marcia

Three-phase motors 4" 2 Poles / 50 Hz Moteurs triphasés 4" à 2 Pôles / 50 Hz Motori trifase 4" a 2 Poli / 50 Hz														
Motor type Moteur type Motore tipo	Motor power Puiss. moteur Potenza motore		Max water temperature Température max eau Temperatura max acqua	Min. cooling speed Min. vitesse de refroidissement Min. velocità di raffreddamento	Starts / hour max Max démarrages / heure Max avviamenti/ora	Revolutions per minute Tours minute Giri al minuto	Efficiency Rendement Rendimento		Power factor Facteur de puissance Fattore di potenza		Nominal current Intensité nominale Corrente nominale		Starting Démarrage Avviamento	
							η [%]		$\cos \varphi$		I_N [A]		$\frac{Ma}{Mn}$	$\frac{Ia}{In}$
	[kW]	[HP]	[°C]	[m/s]	[No.]	[n ⁻¹]	3/4	4/4	3/4	4/4	Fully loaded A pleine charge A pieno carico	Not loaded A vide A vuoto	Direct Direct Diretto	
					(1)	400	400	400	400	400	400	400	400	400
MC405	0,37	0,5	35	0,08	20	2820	53,0	58,0	0,690	0,760	1,2	0,9	2,8	4,1
MC4075	0,55	0,75	35	0,08	20	2815	61,0	64,0	0,645	0,740	1,7	1,4	3,1	4,1
MC41	0,75	1	35	0,08	20	2815	61,5	64,5	0,625	0,720	2,3	1,9	3,3	4,35
MCH415	1,1	1,5	35	0,08	20	2820	68,0	71,0	0,660	0,720	3,1	2,0	3,2	4,5
MCH42	1,5	2	35	0,08	20	2780	64,5	68,0	0,665	0,750	4,3	3,3	3	4,2
MCH43	2,2	3	35	0,08	20	2780	66,5	69,0	0,625	0,730	6,3	5,2	3	5,5
MCH44	3	4	35	0,08	20	2840	74,0	76,0	0,680	0,750	7,6	5,6	2,8	3,95
MCH455	4	5,5	35	0,08	20	2840	76,0	78,5	0,680	0,780	9,4	7,3	3	4,8
MCK42	1,5	2	35	0,08	20	2780	64,5	68,0	0,665	0,750	4,3	3,3	3	4,2
MCK43	2,2	3	35	0,08	20	2780	66,5	69,0	0,625	0,730	6,3	5,2	3	5,5
MCR410	7,5	10	35	0,08	15	2795	76,5	76,5	0,785	0,840	16,8	8,6	3,2	5,3
MCR44	3	4	35	0,08	20	2815	75,0	75,0	0,780	0,850	6,8	4,0	3	5,8
MCR455	4	5,5	35	0,08	15	2840	76,5	77,0	0,755	0,820	9,2	4,9	3,4	5,4
MCR475	5,5	7,5	35	0,08	15	2805	76,5	76,5	0,775	0,830	12,5	6,8	3	5,1

Ma = Starting torque

Mn = Nominal couple

Ia = Starting current

In = Nominal current

Direction of rotation = Left (anti-clockwise) viewed from shaft projection side

(1) = Equally distributed

To supply voltages and admitted variations see the chapter: Motor general notes

Ma = Couple au démarrage

Mn = Couple nominale

Ia = Intensité au démarrage

In = Intensité nominale

Sens de rotation = Gauche (antihoraire) vu du côté bout d'arbre

(1) = Uniformement repartis

Pour les tensions d'alimentation et les variations admises voir le chapitre: Remarques générales moteur

Ma = Coppia di avviamento

Mn = Coppia nominale

Ia = Corrente di avviamento

In = Corrente nominale

Senso di rotazione = Sinistro (antiorario) visto lato sporgenza albero

(1) = Equamente ripartiti

Per le tensioni di alimentazione e le variazioni ammesse vedere il capitolo: Note generali motore

Three-phase motors 6" 2 Poles / 50 Hz Moteurs triphasés 6" à 2 Pôles / 50 Hz Motori trifase 6" a 2 Poli / 50 Hz																
Motor type Moteur type Motore tipo	Motor power Puiss. moteur Potenza motore		Max water temperature Température max eau Temperatura max acqua	Min. cooling speed Min. vitesse de refroidissement Min. velocità di raffreddamento	Starts / hour max Max démarrages / heure Max avviamenti/ora	Revolutions per minute Tours minute Giri al minuto	Efficiency Rendement Rendimento		Power factor Facteur de puissance Fattore di potenza		Nominal current Intensité nominale Corrente nominale		Starting Démarrage Avviamento			
	[kW]	[HP]	[°C]	[m/s]	[No.]	[n ⁻¹]	3/4	4/4	3/4	4/4	Fully loaded A pleine charge A pieno carico	Not loaded A vide A vuoto	Direct Direct Diretto		Star-delta Etoile-triangle Stella-triangolo	Statoric Statorique Statorico
						(1)	400	400	400	400	400	400	400	400	400	400

MAC65-2A	4	5,5	30	0,1	15	2825	67,5	70,0	0,695	0,800	10,3	8,4	1,5	3	1,00	2,10
MAC67-2A	5,5	7,5	30	0,1	15	2815	71,5	72,0	0,720	0,805	13,7	9,3	1,5	3,2	1,05	2,25
MAC610-2A	7,5	10	30	0,1	15	2830	75,5	75,5	0,720	0,800	17,9	11,7	2	4,1	1,40	2,90
MAC612-2A	9,2	12,5	30	0,1	15	2840	77,5	77,5	0,710	0,800	21,3	14,4	1,7	4	1,32	2,80
MAC615-2A	11	15	30	0,1	15	2835	78,5	77,5	0,755	0,825	24,8	14,2	2,5	5,2	1,70	3,60
MAC617-2A	13	17,5	30	0,2	15	2840	78,0	79,0	0,685	0,800	29,7	23,4	2,6	5	1,65	3,50
MAC620-2A	15	20	30	0,2	15	2855	81,0	80,5	0,720	0,800	33,7	18,6	1,95	5	1,70	3,50
MAC625-2A	18,5	25	25	0,2	15	2840	81,5	81,0	0,735	0,820	40,2	22,4	2,5	5,4	1,80	3,80
MAC630-2A	22	30	25	0,2	13	2820	82,5	80,5	0,755	0,825	48,0	23,4	1,7	4,5	1,50	3,20
MAC635-2A	26	35	25	0,2	13	2850	84,0	83,0	0,740	0,815	55,6	28,4	2	5,3	1,75	3,70
MAC640-2A	30	40	25	0,2	13	2845	86,5	85,0	0,735	0,800	62,7	33,2	2	5,3	1,70	3,70

MAC65-2B	4	5,5	40	0,1	15	2870	76,0	76,0	0,745	0,800	9,5	4,6	1,3	3,5	1,15	2,45
MAC67-2B	5,5	7,5	40	0,1	15	2880	77,0	77,0	0,745	0,805	12,8	6,1	1,9	4	1,30	2,80
MAC610-2B	7,5	10	40	0,1	15	2855	78,5	77,5	0,770	0,820	17,0	7,6	2,4	5,1	1,70	3,60
MAC612-2B	9,2	12,5	40	0,1	15	2875	78,5	79,0	0,750	0,810	20,8	9,8	2,4	5	1,65	3,50
MAC615-2B	11	15	40	0,1	15	2860	81,0	80,5	0,755	0,810	24,3	10,6	2,6	5,4	1,80	3,80
MAC617-2B	13	17,5	40	0,1	15	2865	82,0	81,5	0,745	0,810	28,4	13,6	1,3	4,6	1,50	3,20
MAC620-2B	15	20	40	0,1	15	2875	82,0	82,0	0,735	0,800	33,0	17,4	1,5	5	1,70	3,50
MAC625-2B	18,5	25	40	0,1	15	2850	83,0	81,5	0,785	0,830	39,5	16,5	1,4	4,7	1,55	3,30
MAC630-2B	22	30	40	0,1	13	2860	83,5	83,5	0,750	0,820	46,4	22,4	1,8	5	1,70	3,50
MAC635-2B	26	35	40	0,1	13	2860	85,5	84,5	0,745	0,805	55,0	26,7	1,5	4,8	1,60	3,35
MAC640-2B	30	40	40	0,1	13	2870	86,5	85,0	0,755	0,815	62,5	28,3	2	5,7	1,90	4,00
MAC650-2B	37	50	40	0,1	13	2870	87,0	86,0	0,720	0,800	77,5	41,6	2,4	6	2,00	4,20
MAC660-2B	45	60	40	0,3	6	2860	85,0	84,5	0,730	0,800	96,0	49,9	2	5,1	1,70	3,55

Ma = Starting torque
Mn = Nominal couple
Ia = Starting current
In = Nominal current

Direction of rotation = Left (anti-clockwise) viewed from shaft projection side

(1) = Equally distributed

To supply voltages and admitted variations see the chapter: Motor general notes

Ma = Couple au démarrage

Mn = Couple nominale

Ia = Intensité au démarrage

In = Intensité nominale

Sens de rotation = Gauche (antioraire) vu du côté bout d'arbre

(1) = Uniformement repartis

Pour les tensions d'alimentation et les variations admises voir le chapitre: Remarques générales moteur

Ma = Coppia di avviamento

Mn = Coppia nominale

Ia = Corrente di avviamento

In = Corrente nominale

Senso di rotazione = Sinistro (antiorario) visto lato sporgenza albero

(1) = Equamente ripartiti

Per le tensioni di alimentazione e le variazioni ammesse vedere il capitolo: Note generali motore

Single-phase and three-phase motors 2 Pole / 50 Hz - Overall dimensions and weights
 Moteurs monophasés et triphasés 2 Pôles / 50 Hz - Dimensions d'encombrement et poids
 Motori monofase e trifase a 2 Poli / 50 Hz - Dimensioni di ingombro e pesi

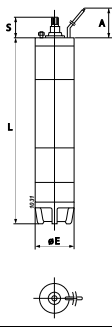
	Motor type Moteur type Motore tipo	Coupling flange Bride d'accouplement Flangia accoppiamento	Motor weight Poids moteur Peso motore	L	Ø E	S	Axial load Charge axiale Carico assiale	Cables outlet Sortie des câbles Uscita cavi		
								Length A Longueur A Lunghezza A	Cross section [mm ²] Section en [mm ²] Sezione in [mm ²]	
									Starting Démarrage Avviamento	
									Direct Direct Diretto	
[kg]	[mm]			[N]	[m]	220 / 230	230 / 240			
MC405M	NEMA 4"	6,8	340	96	38	1500	1,5	1 x (4x1,5) (C.C.: -1)	1 x (4x1,5) (C.C.: -2)	
MC4075M	NEMA 4"	7,8	340	96	38	1500	1,5	1 x (4x1,5) (C.C.: -1)	1 x (4x1,5) (C.C.: -2)	
MC41M	NEMA 4"	9,2	360	96	38	1500	1,5	1 x (4x1,5) (C.C.: -1)	1 x (4x1,5) (C.C.: -2)	
MCH415M	NEMA 4"	10,3	385	96	38	2500	1,5	1 x (4x1,5) (C.C.: -1)	1 x (4x1,5) (C.C.: -2)	
MCH42M	NEMA 4"	11,7	437	96	38	2500	1,5	1 x (4x1,5) (C.C.: -1)	1 x (4x1,5) (C.C.: -2)	
MCH43M	NEMA 4"	14,2	470	96	38	2500	2,5	1 x (4x1,5) (C.C.: -1)	1 x (4x1,5) (C.C.: -2)	
MCHT43M	NEMA 4"	16	565	96	38	2500	2,0	1 x (4x1,5) (C.C.: -1)	-	
MCK42M	NEMA 4"	11,7	437	96	38	4000	1,5	1 x (4x1,5) (C.C.: -1)	1 x (4x1,5) (C.C.: -2)	
MCK43M	NEMA 4"	15,1	505	96	38	4000	1,5	1 x (4x1,5) (C.C.: -1)	1 x (4x1,5) (C.C.: -2)	
MCK455M	NEMA 4"	18,6	538	96	38	4000	3,5	1 x (4x1,5) (C.C.: -1)	-	
MCKT44M	NEMA 4"	18	630	96	38	4000	2,5	1 x (4x1,5) (C.C.: -1)	-	
MCKT455M	NEMA 4"	20	720	96	38	4000	3,5	1 x (4x2) (C.C.: -1)	-	

Section Section Sezione	G	D
[mm ²]	[mm]	
4 x 1,5	5,6	18,8
4 x 2	6	19,5

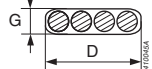

C.C = Motor manufacturing code

C.C = Code construction moteur

C.C = Codice costruttivo motore

Single-phase and three-phase motors 2 Pole / 50 Hz - Overall dimensions and weights
 Moteurs monophasés et triphasés 2 Pôles / 50 Hz - Dimensions d'encombrement et poids
 Motori monofase e trifase a 2 Poli / 50 Hz - Dimensioni di ingombro e pesi

	Motor type Moteur type Motore tipo	Coupling flange Bride d'accouplement Flangia accoppiamento	Motor weight Poids moteur Peso motore	L	Ø E	S	Axial load Charge axiale Carico assiale	Cables outlet Sortie des câbles Uscita cavi		
								Length A Longueur A Lunghezza A	Cross section [mm ²] Section en [mm ²] Sezione in [mm ²]	
									Starting Démarrage Avviamento	
									Direct Direct Diretto	
[kg]	[mm]	[N]	[m]	230	400					
	MC405	NEMA 4"	6,6	320	96	38	1500	1,5	1 x (4x1,5) (C.C.:6)	1 x (4x1,5) (C.C.:8)
	MC4075	NEMA 4"	7,4	340	96	38	1500	1,5	1 x (4x1,5) (C.C.:6)	1 x (4x1,5) (C.C.:8)
	MC41	NEMA 4"	7,6	340	96	38	1500	1,5	1 x (4x1,5) (C.C.:6)	1 x (4x1,5) (C.C.:8)
	MCH415	NEMA 4"	8,7	350	96	38	2500	1,5	1 x (4x1,5) (C.C.:6)	1 x (4x1,5) (C.C.:8)
	MCH42	NEMA 4"	10,2	397	96	38	2500	1,5	1 x (4x1,5) (C.C.:6)	1 x (4x1,5) (C.C.:8)
	MCH43	NEMA 4"	12,5	437	96	38	2500	1,5	1 x (4x1,5) (C.C.:6)	1 x (4x1,5) (C.C.:8)
	MCH44	NEMA 4"	12,8	418	96	38	2500	2,5	1 x (4x1,5) (C.C.:6)	1 x (4x1,5) (C.C.:8)
	MCH455	NEMA 4"	15,3	468	96	38	2500	2,5	1 x (4x1,5) (C.C.:6)	1 x (4x1,5) (C.C.:8)
	MCK42	NEMA 4"	10,2	405	96	38	4000	1,5	1 x (4x1,5) (C.C.:6)	1 x (4x1,5) (C.C.:8)
	MCK43	NEMA 4"	12,5	437	96	38	4000	1,5	1 x (4x1,5) (C.C.:6)	1 x (4x1,5) (C.C.:8)
	**MCR410	NEMA 4"	29	800	96	38	5000	2,5	1 x (4x1,5) (C.C.:6)	1 x (4x1,5) (C.C.:8)
	**MCR44	NEMA 4"	15	520	96	38	5000	1,5	1 x (4x1,5) (C.C.:6)	1 x (4x1,5) (C.C.:8)
	**MCR455	NEMA 4"	20,5	610	96	38	5000	2,5	1 x (4x2) (C.C.:6)	1 x (4x2) (C.C.:8)
	**MCR475	NEMA 4"	24,7	700	96	38	5000	2,5	1 x (4x2) (C.C.:6)	1 x (4x2) (C.C.:8)





Section Section Sezione	G	D
[mm ²]	[mm]	
4 x 1,5	5,6	18,8
4 x 2	6	19,5

C.C = Motor manufacturing code
 ** With plugging cable

C.C = Code construction moteur
 ** Avec cable à connecteur extractible

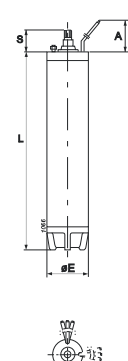
C.C = Codice costruttivo motore
 ** Con cavo a connettore estraibile

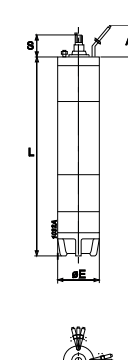
Single-phase and three-phase motors 2 Pole / 50 Hz - Overall dimensions and weights
 Moteurs monophasés et triphasés 2 Pôles / 50 Hz - Dimensions d'encombrement et poids
 Motori monofase e trifase a 2 Poli / 50 Hz - Dimensioni di ingombro e pesi

	Motor type Moteur type Motore tipo	Coupling flange Bride d'accouplement Flangia accoppiamento	Motor weight Poids moteur Peso motore	L	Ø E	S	Axial load Charge axiale Carico assiale	Cables outlet Sortie des câbles Uscita cavi																																																																																																																																																														
								Length A Longueur A Lunghezza A	Cross section [mm ²] Section en [mm ²] Sezione in [mm ²]		Starting Démarrage Avviamento																																																																																																																																																											
									Direct Direct Diretto		Star-delta Etoile-triangle Stella-triangolo																																																																																																																																																											
									400	230	400 / 700	230 / 400																																																																																																																																																										
<div style="display: flex; align-items: center;">  <div style="text-align: center;">  <p>HT HI-TECH</p> </div> </div> <table border="1" style="width: 100%; border-collapse: collapse;"> <tr><td>MAC65-2A</td><td>NEMA 6"</td><td>30,5</td><td>530</td><td>143</td><td>73</td><td>30000</td><td>3,5</td><td>3x(1x2,5) (C.C.:8)</td><td>-</td><td>6x(1x2,5) (C.C.:9)</td><td>-</td></tr> <tr><td>MAC67-2A</td><td>NEMA 6"</td><td>33</td><td>550</td><td>143</td><td>73</td><td>30000</td><td>3,5</td><td>3x(1x2,5) (C.C.:8)</td><td>-</td><td>6x(1x2,5) (C.C.:9)</td><td>-</td></tr> <tr><td>MAC610-2A</td><td>NEMA 6"</td><td>38</td><td>595</td><td>143</td><td>73</td><td>30000</td><td>3,5</td><td>3x(1x2,5) (C.C.:8)</td><td>-</td><td>6x(1x2,5) (C.C.:9)</td><td>-</td></tr> <tr><td>MAC612-2A</td><td>NEMA 6"</td><td>41,7</td><td>640</td><td>143</td><td>73</td><td>30000</td><td>3,5</td><td>3x(1x2,5) (C.C.:8)</td><td>-</td><td>6x(1x2,5) (C.C.:9)</td><td>-</td></tr> <tr><td>MAC615-2A</td><td>NEMA 6"</td><td>44,4</td><td>670</td><td>143</td><td>73</td><td>30000</td><td>3,5</td><td>3x(1x2,5) (C.C.:8)</td><td>-</td><td>6x(1x2,5) (C.C.:9)</td><td>-</td></tr> <tr><td>MAC617-2A</td><td>NEMA 6"</td><td>47,7</td><td>700</td><td>143</td><td>73</td><td>30000</td><td>3,5</td><td>3x(1x4) (C.C.:8)</td><td>-</td><td>6x(1x4) (C.C.:9)</td><td>-</td></tr> <tr><td>MAC620-2A</td><td>NEMA 6"</td><td>52</td><td>715</td><td>143</td><td>73</td><td>30000</td><td>3,5</td><td>3x(1x4) (C.C.:8)</td><td>-</td><td>6x(1x4) (C.C.:9)</td><td>-</td></tr> <tr><td>MAC625-2A</td><td>NEMA 6"</td><td>56</td><td>750</td><td>143</td><td>73</td><td>30000</td><td>3,5</td><td>3x(1x4) (C.C.:8)</td><td>-</td><td>6x(1x4) (C.C.:9)</td><td>-</td></tr> <tr><td>MAC630-2A</td><td>NEMA 6"</td><td>59,8</td><td>790</td><td>143</td><td>73</td><td>30000</td><td>3,5</td><td>3x(1x4) (C.C.:8)</td><td>-</td><td>6x(1x4) (C.C.:9)</td><td>-</td></tr> <tr><td>MAC635-2A</td><td>NEMA 6"</td><td>70</td><td>875</td><td>143</td><td>73</td><td>30000</td><td>3,5</td><td>3x(1x6) (C.C.:8)</td><td>-</td><td>6x(1x4) (C.C.:9)</td><td>-</td></tr> <tr><td>MAC640-2A</td><td>NEMA 6"</td><td>85,7</td><td>1025</td><td>143</td><td>73</td><td>30000</td><td>3,5</td><td>3x(1x6) (C.C.:8)</td><td>-</td><td>6x(1x4) (C.C.:9)</td><td>-</td></tr> </table>											MAC65-2A	NEMA 6"	30,5	530	143	73	30000	3,5	3x(1x2,5) (C.C.:8)	-	6x(1x2,5) (C.C.:9)	-	MAC67-2A	NEMA 6"	33	550	143	73	30000	3,5	3x(1x2,5) (C.C.:8)	-	6x(1x2,5) (C.C.:9)	-	MAC610-2A	NEMA 6"	38	595	143	73	30000	3,5	3x(1x2,5) (C.C.:8)	-	6x(1x2,5) (C.C.:9)	-	MAC612-2A	NEMA 6"	41,7	640	143	73	30000	3,5	3x(1x2,5) (C.C.:8)	-	6x(1x2,5) (C.C.:9)	-	MAC615-2A	NEMA 6"	44,4	670	143	73	30000	3,5	3x(1x2,5) (C.C.:8)	-	6x(1x2,5) (C.C.:9)	-	MAC617-2A	NEMA 6"	47,7	700	143	73	30000	3,5	3x(1x4) (C.C.:8)	-	6x(1x4) (C.C.:9)	-	MAC620-2A	NEMA 6"	52	715	143	73	30000	3,5	3x(1x4) (C.C.:8)	-	6x(1x4) (C.C.:9)	-	MAC625-2A	NEMA 6"	56	750	143	73	30000	3,5	3x(1x4) (C.C.:8)	-	6x(1x4) (C.C.:9)	-	MAC630-2A	NEMA 6"	59,8	790	143	73	30000	3,5	3x(1x4) (C.C.:8)	-	6x(1x4) (C.C.:9)	-	MAC635-2A	NEMA 6"	70	875	143	73	30000	3,5	3x(1x6) (C.C.:8)	-	6x(1x4) (C.C.:9)	-	MAC640-2A	NEMA 6"	85,7	1025	143	73	30000	3,5	3x(1x6) (C.C.:8)	-	6x(1x4) (C.C.:9)	-																								
MAC65-2A	NEMA 6"	30,5	530	143	73	30000	3,5	3x(1x2,5) (C.C.:8)	-	6x(1x2,5) (C.C.:9)	-																																																																																																																																																											
MAC67-2A	NEMA 6"	33	550	143	73	30000	3,5	3x(1x2,5) (C.C.:8)	-	6x(1x2,5) (C.C.:9)	-																																																																																																																																																											
MAC610-2A	NEMA 6"	38	595	143	73	30000	3,5	3x(1x2,5) (C.C.:8)	-	6x(1x2,5) (C.C.:9)	-																																																																																																																																																											
MAC612-2A	NEMA 6"	41,7	640	143	73	30000	3,5	3x(1x2,5) (C.C.:8)	-	6x(1x2,5) (C.C.:9)	-																																																																																																																																																											
MAC615-2A	NEMA 6"	44,4	670	143	73	30000	3,5	3x(1x2,5) (C.C.:8)	-	6x(1x2,5) (C.C.:9)	-																																																																																																																																																											
MAC617-2A	NEMA 6"	47,7	700	143	73	30000	3,5	3x(1x4) (C.C.:8)	-	6x(1x4) (C.C.:9)	-																																																																																																																																																											
MAC620-2A	NEMA 6"	52	715	143	73	30000	3,5	3x(1x4) (C.C.:8)	-	6x(1x4) (C.C.:9)	-																																																																																																																																																											
MAC625-2A	NEMA 6"	56	750	143	73	30000	3,5	3x(1x4) (C.C.:8)	-	6x(1x4) (C.C.:9)	-																																																																																																																																																											
MAC630-2A	NEMA 6"	59,8	790	143	73	30000	3,5	3x(1x4) (C.C.:8)	-	6x(1x4) (C.C.:9)	-																																																																																																																																																											
MAC635-2A	NEMA 6"	70	875	143	73	30000	3,5	3x(1x6) (C.C.:8)	-	6x(1x4) (C.C.:9)	-																																																																																																																																																											
MAC640-2A	NEMA 6"	85,7	1025	143	73	30000	3,5	3x(1x6) (C.C.:8)	-	6x(1x4) (C.C.:9)	-																																																																																																																																																											
<div style="display: flex; align-items: center;">  <div style="text-align: center;">  <p>HT Desert HI-TECH</p> </div> </div> <table border="1" style="width: 100%; border-collapse: collapse;"> <tr><td>MAC65-2B</td><td>NEMA 6"</td><td>39</td><td>552</td><td>143</td><td>73</td><td>45000</td><td>3,5</td><td>3x(1x2,5) (C.C.:8)</td><td>3x(1x4) (C.C.:6)</td><td>6x(1x2,5) (C.C.:9)</td><td>6x(1x2,5) (C.C.:7)</td></tr> <tr><td>MAC67-2B</td><td>NEMA 6"</td><td>42,7</td><td>572</td><td>143</td><td>73</td><td>45000</td><td>3,5</td><td>3x(1x2,5) (C.C.:8)</td><td>3x(1x4) (C.C.:6)</td><td>6x(1x2,5) (C.C.:9)</td><td>6x(1x2,5) (C.C.:7)</td></tr> <tr><td>MAC610-2B</td><td>NEMA 6"</td><td>48</td><td>597</td><td>143</td><td>73</td><td>45000</td><td>3,5</td><td>3x(1x2,5) (C.C.:8)</td><td>3x(1x4) (C.C.:6)</td><td>6x(1x2,5) (C.C.:9)</td><td>6x(1x2,5) (C.C.:7)</td></tr> <tr><td>MAC612-2B</td><td>NEMA 6"</td><td>51</td><td>642</td><td>143</td><td>73</td><td>45000</td><td>3,5</td><td>3x(1x2,5) (C.C.:8)</td><td>3x(1x4) (C.C.:6)</td><td>6x(1x2,5) (C.C.:9)</td><td>6x(1x2,5) (C.C.:7)</td></tr> <tr><td>MAC615-2B</td><td>NEMA 6"</td><td>53,7</td><td>672</td><td>143</td><td>73</td><td>45000</td><td>3,5</td><td>3x(1x2,5) (C.C.:8)</td><td>3x(1x4) (C.C.:6)</td><td>6x(1x2,5) (C.C.:9)</td><td>6x(1x2,5) (C.C.:7)</td></tr> <tr><td>MAC617-2B</td><td>NEMA 6"</td><td>58</td><td>717</td><td>143</td><td>73</td><td>45000</td><td>3,5</td><td>3x(1x4) (C.C.:8)</td><td>3x(1x6) (C.C.:6)</td><td>6x(1x4) (C.C.:9)</td><td>6x(1x4) (C.C.:7)</td></tr> <tr><td>MAC620-2B</td><td>NEMA 6"</td><td>61</td><td>752</td><td>143</td><td>73</td><td>45000</td><td>3,5</td><td>3x(1x4) (C.C.:8)</td><td>3x(1x6) (C.C.:6)</td><td>6x(1x4) (C.C.:9)</td><td>6x(1x4) (C.C.:7)</td></tr> <tr><td>MAC625-2B</td><td>NEMA 6"</td><td>68</td><td>792</td><td>143</td><td>73</td><td>45000</td><td>3,5</td><td>3x(1x4) (C.C.:8)</td><td>3x(1x6) (C.C.:6)</td><td>6x(1x4) (C.C.:9)</td><td>6x(1x4) (C.C.:7)</td></tr> <tr><td>MAC630-2B</td><td>NEMA 6"</td><td>75,4</td><td>877</td><td>143</td><td>73</td><td>45000</td><td>3,5</td><td>3x(1x4) (C.C.:8)</td><td>3x(1x10) (C.C.:6)</td><td>6x(1x4) (C.C.:9)</td><td>6x(1x4) (C.C.:7)</td></tr> <tr><td>MAC635-2B</td><td>NEMA 6"</td><td>92,5</td><td>1027</td><td>143</td><td>73</td><td>45000</td><td>3,5</td><td>3x(1x6) (C.C.:8)</td><td>3x(1x10) (C.C.:6)</td><td>6x(1x4) (C.C.:9)</td><td>6x(1x6) (C.C.:7)</td></tr> <tr><td>MAC640-2B</td><td>NEMA 6"</td><td>104</td><td>1137</td><td>143</td><td>73</td><td>45000</td><td>3,5</td><td>3x(1x6) (C.C.:8)</td><td>3x(1x10) (C.C.:6)</td><td>6x(1x4) (C.C.:9)</td><td>6x(1x6) (C.C.:7)</td></tr> <tr><td>MAC650-2B</td><td>NEMA 6"</td><td>111</td><td>1227</td><td>143</td><td>73</td><td>45000</td><td>3,5</td><td>3x(1x10) (C.C.:8)</td><td>-</td><td>6x(1x6) (C.C.:9)</td><td>6x(1x6) (C.C.:7)</td></tr> <tr><td>MAC660-2B</td><td>NEMA 6"</td><td>119</td><td>1287</td><td>143</td><td>73</td><td>45000</td><td>4,5</td><td>3x(1x10) (C.C.:8)</td><td>-</td><td>6x(1x6) (C.C.:9)</td><td>-</td></tr> </table>											MAC65-2B	NEMA 6"	39	552	143	73	45000	3,5	3x(1x2,5) (C.C.:8)	3x(1x4) (C.C.:6)	6x(1x2,5) (C.C.:9)	6x(1x2,5) (C.C.:7)	MAC67-2B	NEMA 6"	42,7	572	143	73	45000	3,5	3x(1x2,5) (C.C.:8)	3x(1x4) (C.C.:6)	6x(1x2,5) (C.C.:9)	6x(1x2,5) (C.C.:7)	MAC610-2B	NEMA 6"	48	597	143	73	45000	3,5	3x(1x2,5) (C.C.:8)	3x(1x4) (C.C.:6)	6x(1x2,5) (C.C.:9)	6x(1x2,5) (C.C.:7)	MAC612-2B	NEMA 6"	51	642	143	73	45000	3,5	3x(1x2,5) (C.C.:8)	3x(1x4) (C.C.:6)	6x(1x2,5) (C.C.:9)	6x(1x2,5) (C.C.:7)	MAC615-2B	NEMA 6"	53,7	672	143	73	45000	3,5	3x(1x2,5) (C.C.:8)	3x(1x4) (C.C.:6)	6x(1x2,5) (C.C.:9)	6x(1x2,5) (C.C.:7)	MAC617-2B	NEMA 6"	58	717	143	73	45000	3,5	3x(1x4) (C.C.:8)	3x(1x6) (C.C.:6)	6x(1x4) (C.C.:9)	6x(1x4) (C.C.:7)	MAC620-2B	NEMA 6"	61	752	143	73	45000	3,5	3x(1x4) (C.C.:8)	3x(1x6) (C.C.:6)	6x(1x4) (C.C.:9)	6x(1x4) (C.C.:7)	MAC625-2B	NEMA 6"	68	792	143	73	45000	3,5	3x(1x4) (C.C.:8)	3x(1x6) (C.C.:6)	6x(1x4) (C.C.:9)	6x(1x4) (C.C.:7)	MAC630-2B	NEMA 6"	75,4	877	143	73	45000	3,5	3x(1x4) (C.C.:8)	3x(1x10) (C.C.:6)	6x(1x4) (C.C.:9)	6x(1x4) (C.C.:7)	MAC635-2B	NEMA 6"	92,5	1027	143	73	45000	3,5	3x(1x6) (C.C.:8)	3x(1x10) (C.C.:6)	6x(1x4) (C.C.:9)	6x(1x6) (C.C.:7)	MAC640-2B	NEMA 6"	104	1137	143	73	45000	3,5	3x(1x6) (C.C.:8)	3x(1x10) (C.C.:6)	6x(1x4) (C.C.:9)	6x(1x6) (C.C.:7)	MAC650-2B	NEMA 6"	111	1227	143	73	45000	3,5	3x(1x10) (C.C.:8)	-	6x(1x6) (C.C.:9)	6x(1x6) (C.C.:7)	MAC660-2B	NEMA 6"	119	1287	143	73	45000	4,5	3x(1x10) (C.C.:8)	-	6x(1x6) (C.C.:9)	-
MAC65-2B	NEMA 6"	39	552	143	73	45000	3,5	3x(1x2,5) (C.C.:8)	3x(1x4) (C.C.:6)	6x(1x2,5) (C.C.:9)	6x(1x2,5) (C.C.:7)																																																																																																																																																											
MAC67-2B	NEMA 6"	42,7	572	143	73	45000	3,5	3x(1x2,5) (C.C.:8)	3x(1x4) (C.C.:6)	6x(1x2,5) (C.C.:9)	6x(1x2,5) (C.C.:7)																																																																																																																																																											
MAC610-2B	NEMA 6"	48	597	143	73	45000	3,5	3x(1x2,5) (C.C.:8)	3x(1x4) (C.C.:6)	6x(1x2,5) (C.C.:9)	6x(1x2,5) (C.C.:7)																																																																																																																																																											
MAC612-2B	NEMA 6"	51	642	143	73	45000	3,5	3x(1x2,5) (C.C.:8)	3x(1x4) (C.C.:6)	6x(1x2,5) (C.C.:9)	6x(1x2,5) (C.C.:7)																																																																																																																																																											
MAC615-2B	NEMA 6"	53,7	672	143	73	45000	3,5	3x(1x2,5) (C.C.:8)	3x(1x4) (C.C.:6)	6x(1x2,5) (C.C.:9)	6x(1x2,5) (C.C.:7)																																																																																																																																																											
MAC617-2B	NEMA 6"	58	717	143	73	45000	3,5	3x(1x4) (C.C.:8)	3x(1x6) (C.C.:6)	6x(1x4) (C.C.:9)	6x(1x4) (C.C.:7)																																																																																																																																																											
MAC620-2B	NEMA 6"	61	752	143	73	45000	3,5	3x(1x4) (C.C.:8)	3x(1x6) (C.C.:6)	6x(1x4) (C.C.:9)	6x(1x4) (C.C.:7)																																																																																																																																																											
MAC625-2B	NEMA 6"	68	792	143	73	45000	3,5	3x(1x4) (C.C.:8)	3x(1x6) (C.C.:6)	6x(1x4) (C.C.:9)	6x(1x4) (C.C.:7)																																																																																																																																																											
MAC630-2B	NEMA 6"	75,4	877	143	73	45000	3,5	3x(1x4) (C.C.:8)	3x(1x10) (C.C.:6)	6x(1x4) (C.C.:9)	6x(1x4) (C.C.:7)																																																																																																																																																											
MAC635-2B	NEMA 6"	92,5	1027	143	73	45000	3,5	3x(1x6) (C.C.:8)	3x(1x10) (C.C.:6)	6x(1x4) (C.C.:9)	6x(1x6) (C.C.:7)																																																																																																																																																											
MAC640-2B	NEMA 6"	104	1137	143	73	45000	3,5	3x(1x6) (C.C.:8)	3x(1x10) (C.C.:6)	6x(1x4) (C.C.:9)	6x(1x6) (C.C.:7)																																																																																																																																																											
MAC650-2B	NEMA 6"	111	1227	143	73	45000	3,5	3x(1x10) (C.C.:8)	-	6x(1x6) (C.C.:9)	6x(1x6) (C.C.:7)																																																																																																																																																											
MAC660-2B	NEMA 6"	119	1287	143	73	45000	4,5	3x(1x10) (C.C.:8)	-	6x(1x6) (C.C.:9)	-																																																																																																																																																											
Section Section Sezione				F																																																																																																																																																																		
		[mm ²]		[mm]																																																																																																																																																																		
		1 x 2,5		6,2																																																																																																																																																																		
		1 x 4		6,7																																																																																																																																																																		
		1 x 6		7,4																																																																																																																																																																		
		1 x 10		8,6																																																																																																																																																																		
		1 x 16		10																																																																																																																																																																		
		1 x 25		11,9																																																																																																																																																																		
		1 x 35		13,1																																																																																																																																																																		
		1 x 50		15,7																																																																																																																																																																		
		1 x 70		18																																																																																																																																																																		
		1 x 95		21																																																																																																																																																																		

C.C. = Motor manufacturing code

C.C. = Code construction moteur

C.C. = Codice costruttivo motore

Dynamic momentum of the wet end
Moment dynamique partie hydraulique
 Momento dinamico parte idraulica

Standard construction <i>Exécution standard</i> Esecuzione standard		
Electric pump type <i>Electropompe type</i> Elettropompa tipo	J Wet <i>J Mouillé</i> J Bagnato	
	Single stage <i>Mono étagee</i> Monostadio	For each additional stage <i>Pour chaque étage en plus</i> Per ogni stadio in più
	J=1/4 PD ²	
	[kgm ²]	
E6XD20 (x 4")	0,000143	0,000026
E6XD20 (x 6")	0,000190	0,000026
E6XD25 (x 4")	0,000156	0,000026
E6XD25 (x 6")	0,000206	0,000026
E6XD30 (x 4")	0,000182	0,000052
E6XD30 (x 6")	0,000247	0,000052
E6XD35 (x 4")	0,000195	0,000065
E6XD35 (x 6")	0,000260	0,000065
E6XD40 (x 4")	0,000195	0,000065
E6XD40 (x 6")	0,000260	0,000065
E6XD50 (x 4")	0,000208	0,000078
E6XD50 (x 6")	0,000273	0,000078
E6XPD52 (x 4")	0,000208	0,000078
E6XPD52 (x 6")	0,000273	0,000078

Dynamic momentum of the motor
Moment dynamique moteur
Momento dinamico motore

Dynamic momentum of the motor <i>Moment dynamique moteur</i> Momento dinamico motore	
Motor type <i>Moteur type</i> Motore tipo	J=1/4 PD ² [kgm ²]
	
MAC65-2A	0,0020
MAC67-2A	0,0025
MAC610-2A	0,0029
MAC612-2A	0,0045
MAC615-2A	0,0050
MAC617-2A	0,0054
MAC620-2A	0,0070
MAC625-2A	0,0081
MAC630-2A	0,0085
MAC635-2A	0,0110
MAC640-2A	0,0141

Dynamic momentum of the motor <i>Moment dynamique moteur</i> Momento dinamico motore	
Motor type <i>Moteur type</i> Motore tipo	J=1/4 PD ² [kgm ²]
	
MAC65-2B	0,0025
MAC67-2B	0,0037
MAC610-2B	0,0042
MAC612-2B	0,0058
MAC615-2B	0,0064
MAC617-2B	0,0070
MAC620-2B	0,0081
MAC625-2B	0,0085
MAC630-2B	0,0110
MAC635-2B	0,0141
MAC640-2B	0,0161
MAC650-2B	0,0185
MAC660-2B	0,0195

Dynamic momentum of the motor <i>Moment dynamique moteur</i> Momento dinamico motore	
Motor type <i>Moteur type</i> Motore tipo	J=1/4 PD ² [kgm ²]
MC405M	0,00006
MC4075M	0,00006
MC41M	0,00008
MCH415M	0,00013
MCH42M	0,00018
MCH43M	0,00045
MCHT43M	0,00048
MCK42M	0,00021
MCK43M	0,00059
MCK455M	0,00070
MCKT44M	0,00062
MCKT455M	0,00075
MC405	0,00005
MC4075	0,00006
MC41	0,00006
MCH415	0,00007
MCH42	0,00012
MCH43	0,00018
MCH44	0,00017
MCH455	0,00022
MCK42	0,00013
MCK43	0,00021
MCR410	0,00110
MCR44	0,00060
MCR455	0,00084
MCR475	0,00090

Feeding cables
Câbles d'alimentation
Cavi di alimentazione

Calculation of cross-section
Calcul de la section
Calcolo della sezione

The choice of the feeding cable is made considering:

1. acceptable voltage drop
2. power loss in the cable
3. maximum current admitted by the cable.

Le choix du câble d'alimentation s'effectue sur la base:

1. de la chute de tension admissible
2. de la perte de puissance dans la longueur considérée
3. de l'intensité maximale admissible dans le câble.

La scelta del cavo di alimentazione si effettua sulla base:

1. della caduta di tensione ammissibile
2. della potenza dissipata lungo il cavo
3. della corrente massima ammissibile nel cavo.

1.1. Voltage drop ΔU [%] in three-wire cables (resistance only)
Chute de tension ΔU [%] pour câbles tripolaires (résistance seulement)
Caduta di tensione ΔU [%] per cavi tripolari (sola resistenza)

1.1.1. 3-phase motor with - *Moteur triphasé avec* - **Motore trifase con** :

Starting: direct, by statoric impedences, by autotransformer
Démarrage: direct, à impédances statoriques, avec auto-trasformateur
Avviamento: diretto, a impedenze statoriche, con autotrasformatore

1 three-wire cable 3 x s
1 câble trois fils 3 x s
1 cavo tripolare 3 x s

$$\Delta U = \frac{I \cdot L \cdot \cos \varphi}{s \cdot 32,3} + \frac{100}{U} : s = \frac{I \cdot L \cdot \cos \varphi}{\Delta U \cdot 32,3} + \frac{100}{U}$$

1.1.2. 3-phase motor with - *Moteur triphasé avec* - **Motore trifase con**:

Starting: star-delta
Démarrage: étoile-triangle
Avviamento: stella-triangolo

2 three-wire cable 3 x s
2 câbles trois fils 3 x s
2 cavi tripolari 3 x s

$$\Delta U = \frac{I \cdot L \cdot \cos \varphi}{s \cdot 48,5} + \frac{100}{U} : s = \frac{I \cdot L \cdot \cos \varphi}{\Delta U \cdot 48,5} + \frac{100}{U}$$

1.1.3. Single-phase motor
Moteur monophasé
Motore monofase

1 three-wire cable 3 x s
1 câble trois fils 3 x s
1 cavo tripolare 3 x s

$$\Delta U = \frac{I \cdot L \cdot \cos \varphi}{s \cdot 28} + \frac{100}{U} : s = \frac{I \cdot L \cdot \cos \varphi}{\Delta U \cdot 28} + \frac{100}{U}$$

1.2. Voltage drop ΔU [%] in single-wire cables (resistance and reactance)

Chute de tension ΔU [%] pour câbles unipolaires (résistance et réactance)
Caduta di tensione ΔU [%] per cavi unipolari (resistenza e reattanza)

$$\Delta U = 1,73 \cdot I \cdot L \cdot (R \cdot \cos \varphi + X \cdot \sin \varphi) \cdot \frac{100}{U}$$

1.2.1. The voltage drop changes according to the resistance and the reactance induced by single-wires each other according to:
- the cables cross section
- their respective position (single, paired, side by side)
- their angular position (at 120° at 180°)

La chute de tension varie en fonction de la résistance et de la réactance d'induction causée par les conducteurs entre eux et en fonction de:

- la section des câbles
- la position entre eux (single, jumelés côte à côte)
- leur position angulaire (à 120° à 180°)

La caduta di tensione varia in funzione della resistenza e della reattanza induttiva esercitata reciprocamente dai singoli conduttori in funzione:

- della dimensione dei cavi
- della loro posizione reciproca (singoli, abbinati, affiancati)
- della loro disposizione angolare (a 120° a 180°)

1.3. For different supply voltages:

Pour tensions d'alimentation différentes:
Per tensioni di alimentazione diverse:

$$L_N = L \cdot \frac{U_N}{230} : L_N = L \cdot \frac{U_N}{400}$$

1.4. For different power factors:

Pour cosφ différents:
Per cosφ diversi:

$$L_N = L \cdot \frac{0,8}{\cos \varphi}$$

2.1 Power loss P_v along the feeding cables

Perte de puissance P_v le long des câbles d'alimentation
Perdita di potenza P_v lungo i cavi di alimentazione

$$P_v = I^2 \cdot \frac{L}{s \cdot 18,7} [W]$$

I = Motor nominal current [A]
= *Intensité nominale du moteur [A]*
= **Assorbimento nominale del motore [A]**

R = Cable resistance [Ω/m]
= *Résistance et du câble [Ω/m]*
= **Resistenza del cavo [Ω/m]**

U_N = New voltage [V]
= *Nouvelle tension [V]*
= **Nuova tensione [V]**

L = Cable length [m]
= *Longueur du câble [m]*
= **Lunghezza del cavo [m]**

X = Inductive reactance [Ω/m]
= *Réactance d'induction [Ω/m]*
= **Reattanza induttiva [Ω/m]**

ΔU = Voltage drop [%]
= *Chute de tension [%]*
= **Caduta di tensione [%]**

L_N = New cable length [m]
= *Nouvelle longueur du câble [m]*
= **Nuova lunghezza cavo [m]**

U = Nominal voltage [V]
= *Tension nominale [V]*
= **Tensione nominale [V]**

s = Copper wire cross-section [mm^2]
= *Section du conducteur en cuivre [mm^2]*
= **Sezione del conduttore in rame [mm^2]**

Cos φ = Full-load power factor (see table motors operating data)
= *Facteur de puissance à pleine charge (voir tableau caractéristiques moteurs)*
= **Fattore di potenza a pieno carico (vedi tabella caratteristiche motori)**

Maximum permitted current
 Courant maximum admissible
 Corrente massima ammissibile

Tree-wire cables EPR/PVC* 4" insulated Câbles tripolaires isolés en EPR/PVC* 4" Cavi tripolari isolati in EPR/PVC* 4"							
Cable cross-section 3 x s Section du câble 3 x s Sezione del cavo 3 x s	[mm ²]	1,5	2,5	4	6	10	16
Imax allowable I _{max} admissible Imax ammissibile	[A]	15	21	28	36	50	67
Max. operating temperature Température maximum de service Temperatura max di esercizio	[°C]	60	60	60	60	60	60

For different environmental temperatures apply the multiplication coefficient K:
 Pour des températures ambiantes différentes appliquer le coefficient multiplicatif K:
 Per temperature diverse applicare il coefficiente moltiplicativo K:

Ambient temperature Température ambiante Temperatura ambiente	[°C]	10	15	20	25	30	35	40	45	50
In the open air A l'air libre In aria libera	K	1,21	1,16	1,1	1,05	1	0,94	0,88	0,83	0,77

The maximum allowable current values refer to cables installed in free air at 30°C ambient temperature. If the installation conditions are different, multiply the allowable maximum current value in the table by coefficient:
 0,83 (EPR) - 0,78 (PVC) if the cables are ducted in air;
 0,7 (EPR) - 0,76 (PVC) if the cables are buried in the ground (soil temperature 20°C)

Les caractéristiques de l'intensité maximale admissible se réfèrent à des câbles posés à l'air libre à une température ambiante de 30°C. En cas de conditions de pose différentes, multiplier l'intensité maximale admissible du tableau par le coefficient:
 0,83 (EPR) - 0,78 (PVC) en cas de pose sous tube à l'air libre;
 0,7 (EPR) - 0,76 (PVC) en cas de pose enterrée (température du sol 20°C)

I dati di corrente massima ammissibile sono riferiti ad una posa dei cavi in aria libera a temperatura ambiente di 30°C. Per condizioni di posa differenti, moltiplicare la corrente massima ammissibile di tabella per il coefficiente:
 0,83 (EPR) - 0,78 (PVC) in caso di posa in tubo in aria;
 0,7 (EPR) - 0,76 (PVC) in caso di posa interrata (temperatura terreno 20°C)

* Cables in EPR are certified for contact with drinking water in accordance with the following regulations: WRAS (Water Regulations Advisory Scheme) according to BS 6920; ACS (Attestation de Conformité Sanitaire) according to DGS/VS4 99/217 and DGS/VS4 2000/232; Ministerial Decree D.M. 174/04.

* Les câbles en EPR sont certifiés au contact direct avec l'eau potable, conformément aux normes : WRAS (Water Regulations Advisory Scheme) suivant la BS 6920; ACS (Attestation de Conformité Sanitaire) suivant les circulaires DGS/VS4 99/217 et DGS/VS4 2000/232; D.M. 174/04.

* I cavi in EPR sono certificati al contatto con l'acqua potabile, ai sensi delle normative: WRAS (Water Regulations Advisory Scheme) secondo la BS 6920; ACS (Attestation de Conformité Sanitaire) secondo le DGS/VS4 99/217 e DGS/VS4 2000/232; D.M. 174/04.

Maximum permitted current
 Courant maximum admissible
 Corrente massima ammissibile

Tree-wire cables EPDM/EPR* 6" insulated Câbles tripolaires isolés en EPDM/EPR* 6" Cavi tripolari isolati in EPDM/EPR* 6"															
Cable cross-section 3 x s Section du câble 3 x s Sezione del cavo 3 x s	[mm ²]	1,5	2,5	4	6	10	16	25	35	50	70	95	120	150	185
Imax allowable Imax admissible Imax ammissibile	[A]	20	28	37	48	67	90	114	142	172	221	268	311	359	410
Max. operating temperature Température maximum de service Temperatura max di esercizio	[°C]	90	90	90	90	90	90	90	90	90	90	90	90	90	90

For different environmental temperatures apply the multiplication coefficient K:
 Pour des températures ambiantes différentes appliquer le coefficient multiplicatif K:
 Per temperature diverse applicare il coefficiente moltiplicativo K:

Ambient temperature Température ambiante Temperatura ambiente	[°C]	10	15	20	25	30	35	40	45	50
In the open air A l'air libre In aria libera	K	1,15	1,12	1,08	1,04	1	0,96	0,91	0,87	0,82

If two 3-core cables, multiply the max. permitted current detailed in the chart by the coefficient:
 2 with direct or stator starting (cables in parallel)
 1,73 with star-delta starting

* Cables in EPDM/EPR are certified for contact with drinking water in accordance with the following regulations: WRAS (Water Regulations Advisory Scheme) according to BS 6920; ACS (Attestation de Conformité Sanitaire) according to DGS/VS4 99/217 and DGS/VS4 2000/232; Ministerial Decree D.M. 174/04.

En utilisant deux câbles tripolaires, multiplier le courant maximum admissible du tableau par le coefficient:
 2 pour démarrage direct ou par stator (câbles en parallèle)
 1,73 pour démarrage étoile-triangle

* Les câbles en EPDM/EPR sont certifiés au contact direct avec l'eau potable, conformément aux normes: WRAS (Water Regulations Advisory Scheme) suivant la BS 6920; ACS (Attestation de Conformité Sanitaire) suivant les circulaires DGS/VS4 99/217 et DGS/VS4 2000/232; D.M. 174/04.

**N.B. Impiegando due cavi, moltiplicare la corrente massima ammissibile di tabella per il coefficiente:
 2 con avviamento diretto o statorico (cavi in parallelo)
 1,73 con avviamento stella-triangolo**

* I cavi in EPDM/EPR sono certificati al contatto con l'acqua potabile, ai sensi delle normative: WRAS (Water Regulations Advisory Scheme) secondo la BS 6920; ACS (Attestation de Conformité Sanitaire) secondo le DGS/VS4 99/217 e DGS/VS4 2000/232; D.M. 174/04.

Maximum permitted current
 Courant maximum admissible
 Corrente massima ammissibile

Tree-wire cables PVC 6" insulated Câbles tripolaires isolés en PVC 6" Cavi tripolari isolati in PVC 6"															
Cable cross-section 3 x s Section du câble 3 x s Sezione del cavo 3 x s	[mm ²]	1,5	2,5	4	6	10	16	25	35	50	70	95	120	150	185
I _{max} allowable I _{max} admissible I _{max} ammissibile	[A]	16	22	30	38	54	72	90	113	137	176	214	248	287	327
Max. operating temperature Température maximum de service Temperatura max di esercizio	[°C]	70	70	70	70	70	70	70	70	70	70	70	70	70	70

For different environmental temperatures apply the multiplication coefficient K:
 Pour des températures ambiantes différentes appliquer le coefficient multiplicatif K:
 Per temperature diverse applicare il coefficiente moltiplicativo K:

Ambient temperature Température ambiante Temperatura ambiente	[°C]	10	15	20	25	30	35	40	45	50
In the open air A l'air libre In aria libera	K	1,22	1,17	1,12	1,06	1	0,94	0,87	0,79	0,71

If two 3-core cables, multiply the max. permitted current detailed in the chart by the coefficient:
 2 with direct or stator starting (cables in parallel)
 1,73 with star-delta starting

En utilisant deux câbles tripolaires, multiplier le courant maximum admissible du tableau par le coefficient:
 2 pour démarrage direct ou par stator (câbles en parallèle)
 1,73 pour démarrage étoile-triangle

**N.B. Impiegando due cavi, moltiplicare la corrente massima ammissibile di tabella per il coefficiente:
 2 con avviamento diretto o statorico (cavi in parallelo)
 1,73 con avviamento stella-triangolo**

Maximum permitted current
 Courant maximum admissible
 Corrente massima ammissibile

Single-core cables isolated with EPDM/EPR* 6" Câbles unipolaires isolés en EPDM/EPR* 6" Cavi unipolari isolati in EPDM/EPR* 6"														
Cable cross-section 1 x s Section du câble 1 x s Sezione del cavo 1 x s	[mm ²]	2,5	4	6	10	16	25	35	50	70	95	120	150	185
Imax allowable Imax admissible Imax ammissibile	[A]	29	40	52	72	96	126	158	194	251	307	360	417	479
Max. operating temperature Température maximum de service Temperatura max di esercizio	[°C]	90	90	90	90	90	90	90	90	90	90	90	90	90

For different environmental temperatures apply the multiplication coefficient K:
 Pour des températures ambiantes différentes appliquer le coefficient multiplicatif K:
 Per temperature diverse applicare il coefficiente moltiplicativo K:

Ambient temperature Température ambiante Temperatura ambiente	[°C]	10	15	20	25	30	35	40	45	50
In the open air A l'air libre In aria libera	K	1,15	1,12	1,08	1,04	1	0,96	0,91	0,87	0,82

If two 3-core cables, multiply the max. permitted current detailed in the chart by the coefficient:
 2 with direct or stator starting (cables in parallel)
 1,73 with star-delta starting

En utilisant deux câbles tripolaires, multiplier le courant maximum admissible du tableau par le coefficient:
 2 pour démarrage direct ou par stator (câbles en parallèle)
 1,73 pour démarrage étoile-triangle

**N.B. Impiegando due cavi, moltiplicare la corrente massima ammissibile di tabella per il coefficiente:
 2 con avviamento diretto o statorico (cavi in parallelo)
 1,73 con avviamento stella-triangolo**

* Cables in EPDM/EPR are certified for contact with drinking water in accordance with the following regulations: WRAS (Water Regulations Advisory Scheme) according to BS 6920; ACS (Attestation de Conformité Sanitaire) according to DGS/VS4 99/217 and DGS/VS4 2000/232; Ministerial Decree D.M. 174/04.

* Les câbles en EPDM/EPR sont certifiés au contact direct avec l'eau potable, conformément aux normes : WRAS (Water Regulations Advisory Scheme) suivant la BS 6920; ACS (Attestation de Conformité Sanitaire) suivant les circulaires DGS/VS4 99/217 et DGS/VS4 2000/232; D.M. 174/04.

* I cavi in EPDM/EPR sono certificati al contatto con l'acqua potabile, ai sensi delle normative: WRAS (Water Regulations Advisory Scheme) secondo la BS 6920; ACS (Attestation de Conformité Sanitaire) secondo le DGS/VS4 99/217 e DGS/VS4 2000/232; D.M. 174/04.

Maximum permitted current
Courant maximum admissible
 Corrente massima ammissibile

Single-core cables isolated with PVC 6" <i>Câbles unipolaires isolés en PVC 6"</i> Cavi unipolari isolati in PVC 6"														
Cable cross-section 1 x s <i>Section du câble 1 x s</i> Sezione del cavo 1 x s	[mm ²]	2,5	4	6	10	16	25	35	50	70	95	120	150	185
I _{max} allowable <i>I_{max} admissible</i> I _{max} ammissibile	[A]	23	31	41	56	76	102	128	156	202	247	288	334	384
Max. operating temperature <i>Température maximum de service</i> Temperatura max di esercizio	[°C]	70	70	70	70	70	70	70	70	70	70	70	70	70
For different environmental temperatures apply the multiplication coefficient K: <i>Pour des températures ambiantes différentes appliquer le coefficient multiplicatif K:</i> Per temperature diverse applicare il coefficiente moltiplicativo K:														
Ambient temperature <i>Température ambiante</i> Temperatura ambiente	[°C]	10	15	20	25	30	35	40	45	50				
In the open air <i>A l'air libre</i> In aria libera	K	1,22	1,17	1,12	1,06	1	0,94	0,87	0,79	0,71				

If two 3-core cables, multiply the max. permitted current detailed in the chart by the coefficient:
 2 with direct or stator starting (cables in parallel)
 1,73 with star-delta starting

En utilisant deux câbles tripolaires, multiplier le courant maximum admissible du tableau par le coefficient:
 2 pour démarrage direct ou par stator (câbles en parallèle)
 1,73 pour démarrage étoile-triangle

N.B. Impiegando due cavi, moltiplicare la corrente massima ammissibile di tabella per il coefficiente:
 2 con avviamento diretto o statorico (cavi in parallelo)
 1,73 con avviamento stella-triangolo

Max admitted length
 Longueur maxi admise
 Lunghezze massime ammissibili

3-core EPDM/EPR o PVC* power cables Câbles d'alimentation tripolaires en EPDM/EPR o PVC* Cavi di alimentazione tripolari in EPDM/EPR o PVC*													
Cable cross-section 3 (4) x [mm ²] Câble de section 3 (4) x [mm ²] Cavo di sezione 3 (4) x [mm ²]													
1	230	284	470					328	543				
	400							570					
1.5	230	189	313	503				218	362	580			
	400							380					
2	230	142	235	377	566			164	271	435			
	400							285	472				
2.5	230	113	188	302	452			131	217	348	522		
	400							228	377				
3	230	95	157	251	377			109	181	290	435		
	400							190	315	505			
4	230	71	117	188	283	459		82	136	218	327	530	
	400							142	236	379	568		
5	230	57	94	151	226	367	574	66	109	174	261	424	
	400							114	189	303	454		
6	230	47	78	126	189	306	478	55	90	145	218	354	552
	400							95	157	252	379		
7	230	41	67	108	162	262	410	47	78	124	187	303	474
	400							81	135	216	324	527	
8	230	35	59	94	141	230	359	41	68	109	163	265	414
	400							71	118	189	284	461	
9	230	32	52	84	126	204	319	36	60	97	145	236	368
	400							63	105	168	252	410	
10	230	28	47	75	113	184	287	33	54	87	131	212	331
	400							57	94	151	227	369	576
11	230	26	43	69	103	167	261	30	49	79	119	193	301
	400							52	86	138	206	335	524
12	230	24	39	63	94	153	239	27	45	73	109	177	276
	400							47	79	126	189	307	480
13	230	22	36	58	87	141	221	25	42	67	100	163	255
	400							44	73	116	175	284	443
14	230	20	34	54	81	131	205	23	39	62	93	152	237
	400							41	67	108	162	264	412
15	230	19	31	50	75	122	191	22	36	58	87	141	221
	400							38	63	101	151	246	384
16	230	18	29	47	71	115	179	20	34	54	82	133	207
	400							36	59	95	142	231	360
17	230	17	28	44	67	108	169	19	32	51	77	125	195
	400							34	56	89	134	217	339
18	230	16	26	42	63	102	159	18	30	48	73	118	184
	400							32	52	84	126	205	320
19	230	15	25	40	60	97	151	17	29	46	69	112	174
	400							30	50	80	120	194	303
20	230	14	23	38	57	92	144	16	27	44	65	106	166
	400							28	47	76	114	184	288

The lengths given in boldface type refer solely to cables in EPDM/EPR.

Make sure that the current considered is effectively that absorbed by the motor in the real operating conditions.

The cable lengths refer to 30°C ambient temperature; installation in air; 50Hz frequency; cosj = 0.8 and 3% permissible voltage drop. For other operating conditions, refer to the selection procedure detailed: power cables.

Make sure that the section of the riser cable is the same as the section of the motor output cable, or larger.

Les longueurs marquées en caractères gras se réfèrent aux câbles en EPDM/EPR seulement.

Vérifier que le courant considéré soit effectivement celui absorbé par le moteur dans les conditions réelles de service.

Les longueurs des câbles se réfèrent à une température ambiante de 30°C; pose à l'air libre; alimentation 50Hz; cosj = 0,8 et chute de tension admissible = 3%.
 Pour des conditions différentes voir la procédure de sélection: Câbles d'alimentation.

Vérifier que la section sélectionnée pour le câble de remontée soit supérieure ou égale à la section du câble de sortie moteur.

Le lunghezze contrassegnate in grassetto sono riferite solo ai cavi in EPDM/EPR.

Assicurarsi che la corrente considerata sia effettivamente quella assorbita dal motore nelle condizioni reali d'esercizio.

Le lunghezze dei cavi sono riferite ad una temperatura ambiente di 30°C; installazione in aria; alimentazione 50Hz; cosj = 0,8 e caduta di tensione ammessa = 3%.

Per condizioni diverse, verificare accuratamente i parametri di selezione vedi procedura di selezione: cavi di alimentazione.

Assicurarsi che la sezione selezionata per il cavo di risalita sia maggiore o uguale alla sezione del cavo d'uscita motore.

Max admitted length
Longueur maxi admise
Lunghezze massime ammissibili

Max length [m] - EPDM*/EPR or PVC three-pole power cables
Longueur maxi admise [m] - EPDM*/EPR ou PVC three-pole power cables
Lunghezza MAX [m] - Cavo di alimentazione Tripolare EPDM*/EPR o PVC

Direct or statoric starting - 3 cables Motor exit- 1 Cable with section (s) 3 x ...
Demarrage direct ou statorique - Sortie moteur 3 câbles - 1 Câble, section (s) 3 x ...
Avviamento diretto o statorico - Motore con uscita 3 cavi - 1 cavo di sezione (s) 3 x ...

I [A]	S [mm ²]															
	1,5	2,5	4	6	10	16	25	35	50	70	95	120	150	185		
2,5	228	377														
5	114	189	303	454												
7,5	76	126	202	303	492											
10	57	94	151	227	369	576										
15	38	63	101	151	246	384	590									
20	28	47	76	114	184	288	443	597								
25		38	61	91	148	231	354	477								
30			50	76	123	192	295	398	524							
40				57	92	144	221	298	393	543						
50					74	115	177	239	315	434	564					
60					61	96	148	199	262	362	470	566				
70						82	126	170	225	310	403	485	560			
80						72	111	149	197	271	353	424	490	574		
90						64	98	133	175	241	314	377	435	510		
100							89	119	157	217	282	339	392	459		
120								99	131	181	235	283	326	383		
140									85	112	155	202	242	280	328	
160										98	136	176	212	245	287	
180											121	157	189	218	255	
200											109	141	170	196	230	
220											99	128	154	178	209	
240												118	141	163	191	
260												109	131	151	177	
280													121	140	164	
300														113	131	153
320															122	143

Make sure that the current considered is effectively that absorbed by the motor in the real operating conditions.

The lengths given in boldface type refer solely to cables in EPDM/EPR

The cable lengths refer to 30°C ambient temperature; installation in air; 400[V] 50[Hz] power supply; cosφ = 0.8 and 3% permissible voltage drop.

Check the selection parameters carefully if the conditions are different (see "Calculation of cross-section" and "Maximum permitted current")

Make sure that the section of the riser cable is the same as the section of the motor output cable, or larger.

If the conditions are different, please contact our sales organization.

* The EPDM cables are fit for contact with drinking water, certified by WRAS (Water Regulations Advisory Scheme) in compliance with standard BS 6920.

Vérifier que le courant considéré soit effectivement celui absorbé par le moteur dans les conditions réelles de service.

Les longueurs marquées en caractères gras se réfèrent aux câbles en EPDM/EPR seulement

Les longueurs des câbles se réfèrent à une température ambiante de 30°C; pose à l'air libre; alimentation 400[V] 50[Hz]; cosφ = 0.8 et chute de tension admissible = 3%. En cas de conditions différentes, vérifier soigneusement les paramètres de sélection (voir "Calcul de la section" et "Courant maximum admissible").

Vérifier que la section sélectionnée pour le câble de remontée soit supérieure ou égale à la section du câble de sortie moteur.

En cas de conditions différentes, contacter notre service commercial

* Les câbles en EPDM sont indiqués pour le contact avec l'eau potable, certifiés par le WRAS (Water Regulations Advisory Scheme) conformément à la réglementation BS 6920.

Assicurarsi che la corrente considerata sia effettivamente quella assorbita dal motore nelle condizioni reali d'esercizio.

Le lunghezze contrassegnate in grassetto sono riferite solo ai cavi in EPDM/EPR.

Le lunghezze dei cavi sono riferite ad una temperatura ambiente di 30°C; installazione in aria; alimentazione 400[V] 50[Hz]; cosφ = 0.8 e caduta di tensione ammessa = 3%.

Per condizioni diverse, verificare accuratamente i parametri di selezione (vedi "Calcolo della sezione" e "Corrente massima ammissibile").

Assicurarsi che la sezione selezionata per il cavo di risalita sia maggiore o uguale alla sezione del cavo d'uscita motore.

Per condizioni diverse, interpellare la sede o la rete di vendita.

* I cavi in EPDM sono idonei al contatto con l'acqua potabile, certificati dal WRAS (Water Regulations Advisory Scheme) secondo la normativa BS 6920

Max admitted length
Longueur maxi admise
Lunghezze massime ammissibili

Max length [m] - EPDM*/EPR or PVC three-pole power cables - Longueur maxi admise [m] - EPDM*/EPR ou PVC three-pole power cables

Lunghezza MAX [m] - Cavo di alimentazione Tripolare EPDM*/EPR o PVC

Star-delta starting - 6 cables Motor exit / Démarrage étoile-triangle - Sortie moteur 6 câbles / Avviamento stella-triangolo - Motore con uscita 6 cavi
2 Cables wit section 3 x ... / 2 Câble, section (s) 3 x ... / 2 cavi di sezione (s) 3 x ...

I [A]	S [mm ²]													
	1,5	2,5	4	6	10	16	25	35	50	70	95	120	150	185
10	85	142	227	341	553									
15	57	94	151	227	369	576								
20	43	71	114	170	277	432								
25	34	57	91	136	221	346	531							
30	28	47	76	114	184	288	443	597						
40		35	57	85	138	216	332	447	590					
50			45	68	111	173	266	358	472					
60			38	57	92	144	221	298	393	543				
70				49	79	124	190	256	337	465				
80				43	69	108	166	224	295	407	529			
90					61	96	148	199	262	362	470	566		
100					55	86	133	179	236	326	423	509	588	
120						72	111	149	197	271	353	424	490	574
140						62	95	128	169	233	302	364	420	492
160							83	112	147	203	265	318	367	430
180							74	99	131	181	235	283	326	383
200								89	118	163	212	254	294	344
220								81	107	148	192	231	267	313
240								75	98	136	176	212	245	287
260									91	125	163	196	226	265
280									84	116	151	182	210	246
300										109	141	170	196	230
320										102	132	159	184	215

Make sure that the current considered is effectively that absorbed by the motor in the real operating conditions.

The lengths given in boldface type refer solely to cables in EPDM/EPR

The cable lengths refer to 30°C ambient temperature; installation in air; 400[V] 50[Hz] power supply; $\cos\phi = 0.8$ and 3% permissible voltage drop. Check the selection parameters carefully if the conditions are different (see "Calculation of cross-section" and "Maximum permitted current")

Make sure that the section of the riser cable is the same as the section of the motor output cable, or larger.

If the conditions are different, please contact our sales organization.

* The EPDM cables are fit for contact with drinking water, certified by WRAS (Water Regulations Advisory Scheme) in compliance with standard BS 6920.

Vérifier que le courant considéré soit effectivement celui absorbé par le moteur dans les conditions réelles de service.

Les longueurs marquées en caractères gras se réfèrent aux câbles en EPDM/EPR seulement.

Les longueurs des câbles se réfèrent à une température ambiante de 30°C; pose à l'air libre; alimentation 400[V] 50[Hz]; $\cos\phi = 0.8$ et chute de tension admissible = 3%. En cas de conditions différentes, vérifier soigneusement les paramètres de sélection (voir "Calcul de la section" et "Courant maximum admissible").

Vérifier que la section sélectionnée pour le câble de remontée soit supérieure ou égale à la section du câble de sortie moteur.

En cas de conditions différentes, contacter notre service commercial

* Les câbles en EPDM sont indiqués pour le contact avec l'eau potable, certifiés par le WRAS (Water Regulations Advisory Scheme) conformément à la réglementation BS 6920.

Assicurarsi che la corrente considerata sia effettivamente quella assorbita dal motore nelle condizioni reali d'esercizio.

Le lunghezze contrassegnate in grassetto sono riferite solo ai cavi in EPDM/EPR.

Le lunghezze dei cavi sono riferite ad una temperatura ambiente di 30°C; installazione in aria; alimentazione 400[V] 50[Hz]; $\cos\phi = 0.8$ e caduta di tensione ammessa = 3%. Per condizioni diverse, verificare accuratamente i parametri di selezione (vedi "Calcolo della sezione" e "Corrente massima ammissibile").

Assicurarsi che la sezione selezionata per il cavo di risalita sia maggiore o uguale alla sezione del cavo d'uscita motore.

Per condizioni diverse, interpellare la sede o la rete di vendita.

* I cavi in EPDM sono idonei al contatto con l'acqua potabile, certificati dal WRAS (Water Regulations Advisory Scheme) secondo la normativa BS 6920

Generator power
 Puissance du générateur
 Potenza del generatore

When an electric generator has to be used to supply the motor, it should be carefully selected.
 A chart is provided giving the minimum rating in kW and kVA of the generators used to supply the motors.

*Dans le cas d'utilisation d'un générateur électrique pour alimenter le moteur, le choix doit être avisé.
 Nous fournissons un tableau indicatif des puissances minimum en kW et en kVA des générateurs pour l'alimentation des moteurs électriques*

Quando si deve utilizzare un generatore elettrico per l'alimentazione del motore, è necessaria un'oculata scelta.
 Forniamo una tabella indicativa delle potenze minime in kW ed in kVA dei generatori per l'alimentazione dei motori elettrici.

Electric motor power Puissance moteur électrique Potenza motore elettrico		Generator power Puissance du générateur Potenza del generatore	
		Direct starting Démarrage direct Avviamento diretto	
[kW]	[HP]	[kW]	[kVA]
2.2	3	6	7.5
3	4	8	10
4	5,5	10	12,5
5,5	7,5	12,5	15,6
7,5	10	15	18,8
9,2	12,5	18,8	23,5
11	15	22,5	28
13	17,5	26,4	33
15	20	30	38
18,5	25	40	50
22	30	45	57
26	35	52	65
30	40	60	75
37	50	75	94
45	60	90	112
51	70	105	131
59	80	120	150
66	90	135	170
75	100	150	190
92	125	185	230
110	150	210	260

Electric motor power Puissance moteur électrique Potenza motore elettrico		Generator power Puissance du générateur Potenza del generatore	
		Star-delta starting Démarrage étoile-triangle Avviamento stella-triangolo	
[kW]	[HP]	[kW]	[kVA]
-	-	-	-
3	4	6	7,5
4	5,5	8	10
5,5	7,5	10,8	13,5
7,5	10	14	17,5
9,2	12,5	17,2	21,5
11	15	20,5	25,5
13	17,5	23,6	29,5
15	20	27	34
18,5	25	33	42
22	30	40	50
26	35	45	57
30	40	52	65
37	50	65	81
45	60	77	97
51	70	90	112
59	80	102	128
66	90	115	144
75	100	128	160
92	125	158	198
110	150	190	237

VALUES VALEURS GRANDEZZA		ALTERNATING CURRENT COURANT ALTERNATIF CORRENTE ALTERNATA	
		SINGLE-PHASE MONOPHASE MONOFASE	THREE-PHASE TRIPHASE TRIFASE
Absorbed power (active) <i>Puissance absorbée (active)</i> Potenza assorbita (attiva)	[kW]	$P_a = \frac{U \cdot I \cdot \cos \varphi}{1000}$	$P_a = \frac{1,73 \cdot U \cdot I \cdot \cos \varphi}{1000}$
Yield power <i>Puissance utile</i> Potenza resa	[kW]	$P_r = \frac{U \cdot I \cdot \cos \varphi \cdot \eta_M}{1000}$	$P_r = \frac{1,73 \cdot U \cdot I \cdot \cos \varphi \cdot \eta_M}{1000}$
Absorbed current <i>Courant absorbé</i> Corrente assorbita	[A]	$I = \frac{P_r \cdot 1000}{U \cdot \cos \varphi \cdot \eta_M}$	$I = \frac{P_r \cdot 1000}{1,73 \cdot U \cdot \cos \varphi \cdot \eta_M}$
Power factor (cos φ) <i>Facteurs de puissance (cos φ)</i> Fattore di potenza (cos φ)	[0,.....]	$\cos \varphi = \frac{P_a \cdot 1000}{U \cdot I}$	$\cos \varphi = \frac{P_a \cdot 1000}{1,73 \cdot U \cdot I}$
Nominal torque <i>Couple nominal</i> Coppia nominale	[Nm]	$M_N = \frac{P_r \cdot 1000}{0,105 \cdot n}$	
Motor efficiency <i>Rendement du moteur</i> Rendimento motore	[%]	$\eta_M = \frac{P_r}{P_a} \cdot 100$	
Synchronous speed <i>Vitesse de synchronisme</i> Velocità sincrona	[n ⁻¹]	$n_s = \frac{f \cdot 120}{\text{No. Poli / Poles / Pôles}}$	
Sliding <i>Glissement</i> Scorrimento	[%]	$S = \frac{n_s - n}{n_s} \cdot 100$	

Tolerances on the guaranteed values of the electrical characteristics of asynchronous motors as per CEI norms in accordance with IEC norms.

Tolérances sur les valeurs garanties des caractéristiques électriques des moteurs asynchrones selon les Normes CEI en accord avec les Normes IEC.

Tolleranze sui valori garantiti delle caratteristiche elettriche dei motori asincroni, secondo Norme CEI in accordo con le Norme IEC.

VALUE VALEURS GRANDEZZA		TOLERANCE TOLERANCE TOLLERANZA
Real efficiency <i>Rendement réel</i> Rendimento effettivo	[η]	$-0,15 \cdot (1 - \eta_{\phi})$ [%]
Power factor <i>Facteur de puissance</i> Fattore di potenza	[cos φ]	$-\frac{1}{6} \cdot (1 - \cos \varphi)$ [nim: 0,02 max: 0,07]
Sliding <i>Glissement</i> Scorrimento	[S]	± 20%

VALUE VALEURS GRANDEZZA		TOLERANCE TOLERANCE TOLLERANZA
Maximum torque <i>Couple maximal</i> Coppia massima	[M _M]	- 10% (min 1,6 M _N) [Nm]
Starting torque <i>Couple de démarrage</i> Coppia di spunto	[M _s]	+ 25% - 15%
Starting current <i>Intensité de démarrage</i> Corrente di spunto	[I _s]	+ 20% [A]

Reactive power compensation
 Compensation de la puissance réactive
 Compensazione della potenza reattiva

Asynchronous motors absorb, from the main, "apparent" electrical power which is partly "active" power, and partly "reactive" power; the latter is used for motor magnetization and cannot be technically eliminated.

The ratio of "active power" to "apparent power" forms the "power factor" or $\cos \varphi$. The absorbed reactive power on the line can be reduced, according with the current rules, modifying the phase displacement between absorbed current and supply tension. Everything must be realised using an appropriate power capacitors battery.

Les moteurs asynchrones absorbent sur le réseau une puissance électrique "apparente" constituée en partie d'une puissance "active" et en partie d'une puissance "réactive".

Cette dernière sert à la magnétisation du moteur et ne peut pas être techniquement supprimée.

Le rapport entre "puissance active" et "puissance apparente" constitue le "facteur de puissance" ou $\cos \varphi$.

La puissance réactive absorbée sur la ligne peut être réduite, selon les normes en vigueur, en modifiant le déphasage entre courant absorbé et tension d'alimentation.

Ceci devra être réalisé en utilisant une adéquate batterie des condensateurs de puissance.

I motori asincroni assorbono dalla rete potenza elettrica "apparente" costituita in parte da potenza "attiva" ed in parte da potenza "reattiva"; quest'ultima serve alla magnetizzazione del motore e non può essere tecnicamente soppressa.

Il rapporto fra "potenza attiva" e "potenza apparente" costituisce il "fattore di potenza", o $\cos \varphi$.

La potenza reattiva assorbita sulla linea può essere ridotta, in base alle norme vigenti, modificando lo sfasamento tra corrente assorbita e la tensione di alimentazione. Ciò dovrà essere realizzato utilizzando opportuna batteria di condensatori di potenza.

Nomogram for determining P_c power [kVAR] of phase-shift capacitors
 Nomogramme pour la détermination de la puissance P_c [kVAR] des condensateurs de rattrapage.
 Nomogramma per la determinazione della potenza P_c [kVAR] dei condensatori di rifasamento.

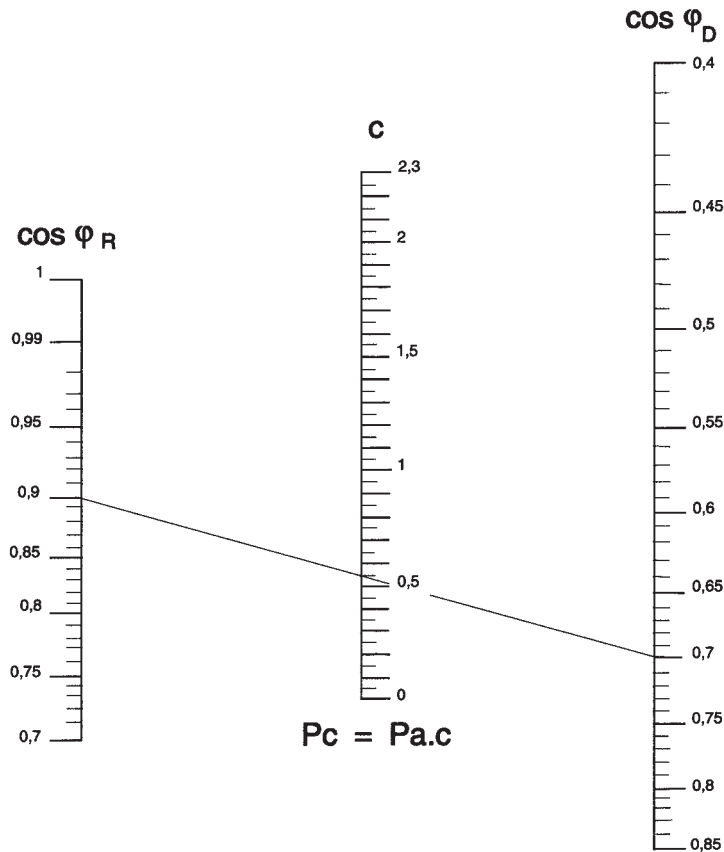

Example:
 Electrical input (active) P_a motor = 20 kW
 Available power factor $\cos \varphi_D = 0,7$
 Required power factor $\cos \varphi_R = 0,9$
 Multiplying factor (from nomogram) $c = 0,54$
 Phase-shift capacitor power P_c
 $P_c = P_a \times c = 20 \times 0,54 = 10,8$ kVAR

Exemples:
 Puissance absorbée (active) du moteur $P_a = 20$ kW
 Factor de puissance disponible $\cos \varphi_D = 0,7$
 Factor de puissance recherchée $\cos \varphi_R = 0,9$
 Facteur multiplicatif (du nomogramme) $c = 0,54$
 Puissance des condensateurs P_c
 $P_c = P_a \times c = 20 \times 0,54 = 10,8$ kVAR

Esempio:
 Potenza attiva motore $P_a = 20$ kW
 Fattore di potenza disponibile $\cos \varphi_D = 0,7$
 Fattore di potenza richiesto $\cos \varphi_R = 0,9$
 Fattore moltiplicativo da nomogramma $c = 0,54$
 Potenza del condensatore di rifasamento P_c
 $P_c = P_a \times c = 20 \times 0,54 = 10,8$ kVAR

DCL Low level safety device
DCL Dispositif pour défaut d'eau et contrôle niveau
DCL Dispositivo contro la marcia a secco e controllo del livello

The conductivity electronic device DCL, is used for monitoring the levels of conductive liquids in wells, tanks or reservoirs.
In the case of minimum and maximum level control (prevention of dry running and automatic reset of the electric pump), the relay is at rest until the liquid reaches the upper level.
At this point the relay starts working thereby exciting the remote control switch coil (causing the electric pump to start and keeps this state until the liquid drows down below the minimum level.

During minimum level checking (prevention of dry running) relay remains constantly excited if pumped liquids is available.
Relay is not excited when there is no liquid or voltage lacks.
If so, relay must be manually reset.

Le dispositif électroniques à conductivité DCL, sert à relever ou à contrôler les niveau du liquide conducteur dans les puits, les bâches ou les réservoirs.

En cas de contrôle du niveau minimum ou maximum (protection contre la marche à sec et remise en marche automatique de l'électropompe), le relais se maintient en situation de repos tant que le liquide n'a pas atteint le niveau supérieur. A ce point, le relais excite la bobine du telerupteur (qui provoque le démarrage de l'électropompe) et la maintient jusqu'à ce que le liquide descend sous le niveau minimum.

Quand on va vérifier le niveau minimum (protection contre la marche à sec) le relais reste toujours excité en présence du liquide pompé. Il n'est pas excité en absence du liquide ou quand la tension manque. Dans cette occasion le relais doit être rearmé manuellement.

I dispositivo elettronico a conduttività DCL, serve a rilevare o controllare i livelli dei liquidi conduttivi in pozzi, vasche o serbatoi. Nel caso di controllo di minimo e massimo livello (protezione contro la marcia a secco e riavviamento automatico della elettropompa), il relè si mantiene in stato di riposo fintanto che il liquido non ha raggiunto il livello superiore. A questo punto, il relè entra in conduzione eccitando la bobina del teleruttore (che provoca, tramite l'apparecchiatura elettrica, l'avviamento dell'elettropompa) e mantiene tale stato finchè il liquido non scende sotto in livello minimo.

Nel caso di semplice controllo di minimo livello (protezione contro la marcia a secco), il relè rimane costantemente eccitato in presenza del liquido diseccitandosi in assenza di questo o per mancanza di tensione e deve essere riarmato manualmente.

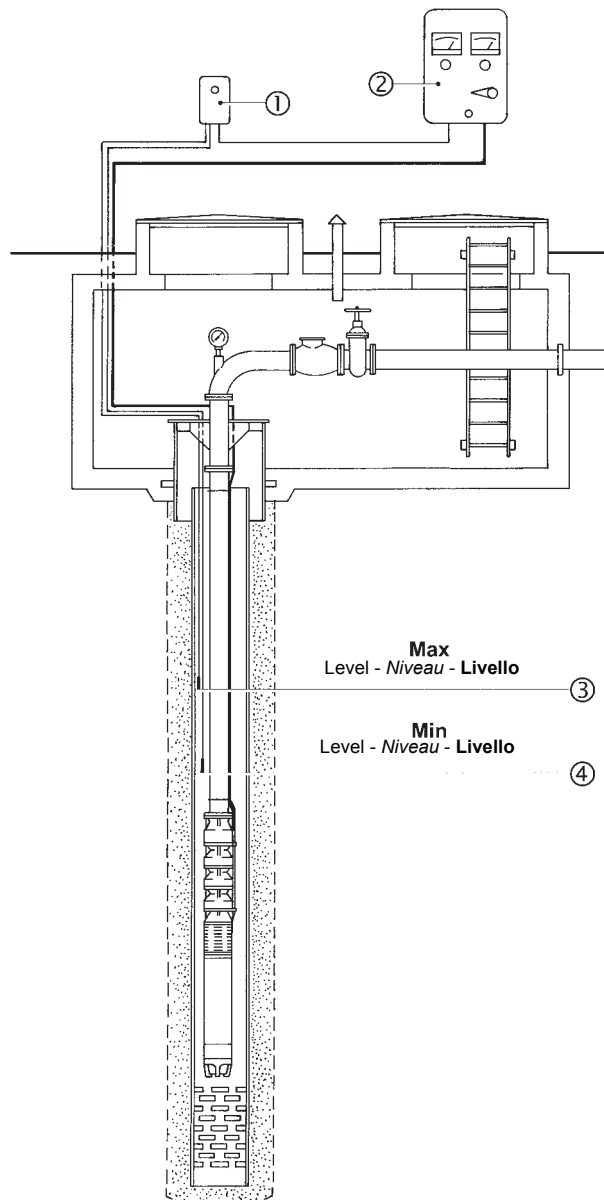

- 1) Low level safety device
- 2) Electric equipment
- 3) Maximum level electric probe
- 4) Minimum level electric probe

- 1) Dispositif complet pour défaut d'eau
- 2) Appareillage électrique
- 3) Sondes électriques au max. de niveau
- 4) Sondes électriques au min. de niveau

- 1) Dispositivo contro la marcia a secco
- 2) Apparecchiatura elettrica
- 3) Sonda elettrica max. livello
- 4) Sonda elettrica min. livello

Accessories
Accessoires
Accessori

T-412 Temperature monitoring device for submersed electric motors
T-412 Appareillage de contrôle de la température des moteurs électriques immergés
T-412 Apparechiatura di controllo temperatura motori elettrici sommersi

T412 monitors the temperature inside the electric motor.

Connected to the PT100 probe (housed in the electric motor), it is able to read operating temperatures from 0-200°C.
T412 is supplied without a setting.

How to make the setting:

- Start the electric pump and set it to the operating point with the highest power input. The internal temperature will rise progressively and will be monitored by the probe. When it has reached full rate (this may take up to 2 hours, depending on the motor), the temperature reading will stabilize.
- Once the temperature has become stable, select a value equal to the temperature reading +3°C for the first alarm setting. The alarm must record the excess temperature so as to produce documentation upon the first inspection;
- The setting for the second alarm, which must stop the motor, must equal the temperature reading +6°C; the excess temperature recording can be automatic, but must occur with a delay of at least 15 minutes from the stopping action or when the internal temperature of the motor is 20°C less than the alarm temperature setting;
ACTIVATION OF THE 2nd ALARM, WHICH STOPS THE MOTOR, WILL OCCUR WHEN:
 - There is an overload
 - There is a poor cooling action
 - There are too frequent starts

With the motor rotor wound in:

- In PVC, the maximum temperature setting of the second alarm must be 58°C
- In PE2+PA, the maximum temperature setting of the second alarm must be 75°C.
This device can also be used for monitoring the temperature of bearings, lubricants, in surface electric motors and machinery in general.
The device complies with electromagnetic compatibility standards CEI EN-50081-2 and 50082-2.
Dimensions: 48*96 mm DIN 43700
depth:130 mm.

L'appareillage T412 sert à contrôler la température interne du moteur électrique.

Branché à la sonde PT100 (logée à l'intérieur du moteur électrique) il permet la lecture de la température de fonctionnement entre 0-200°C.
L'appareillage T412 est fourni sans réglage.

Mode de réglage :

- Mettre l'électropompe en marche et se placer dans le point de travail où la puissance absorbée est la plus élevée, la température interne augmentera progressivement et sera relevée par la sonde. Au régime établi (deux heures peuvent s'écouler, suivant le type de moteur) la température lue se stabilisera.
- Quand la température est stable, régler la première alarme à une valeur égale à la température lue +3°C, l'alarme doit enregistrer le dépassement pour en faire l'acquisition au premier contrôle;
- La deuxième alarme, qui doit commander l'arrêt du moteur, devra être étalonnée à une valeur égale à la température lue +6°C; le redémarrage, avec enregistrement du dépassement, peut être automatique mais doit avoir lieu avec un retard, par rapport à l'arrêt, d'au moins 15 minutes ou à une température interne du moteur inférieure de 20°C par rapport à la température de réglage de l'alarme.
L'INTERVENTION DE LA 2e ALARME, AVEC ARRÊT DU MOTEUR, SE PRODUIT:
 - En cas de surcharge ;
 - En cas de refroidissement insuffisant;
 - En cas de démarrages trop fréquents.

Avec moteur à rotor bobiné:

- En PVC, la température maximum de réglage de la deuxième alarme est de 58°C.
- En PE2+PA, la température maximum de réglage de la deuxième alarme est de 75°C.
Ce dispositif pourra aussi être utilisé pour contrôler les températures des roulements, des lubrifiants, dans les moteurs électriques de surface et dans les machines en général.
L'appareillage est conforme aux normes de compatibilité électromagnétique CEI EN-50081-2 et 50082-2.
Dimensions: 48*96 mm DIN 43700
profondeur: 130 mm.

L'apparechiatura T412, serve a monitorare la temperatura interna del motore elettrico.

Collegata alla sonda PT100 (alloggiata all'interno del motore elettrico) permette la lettura della temperatura di funzionamento tra 0-200°C .
L'apparechiatura T412 viene fornita senza il settaggio.

Modalità per il settaggio:

- Avviare l'elettropompa e posizionarsi nel punto di lavoro a maggiore potenza assorbita, la temperatura nel suo interno crescerà progressivamente e verrà monitorata dalla sonda. A regime (a seconda del motore possono trascorrere fino a 2 ore) la temperatura letta si stabilizzerà.
- A lettura stabile della temperatura tarare il primo allarme ad un valore pari alla temperatura letta +3°C, l'allarme deve registrare il superamento per averne documentazione alla prima ispezione;
- Il secondo allarme, che deve comandare l'arresto del motore, dovrà essere tarato ad un valore pari alla temperatura letta +6°C; il riavviamento, con registrazione del superamento, può essere automatico ma deve avvenire con un ritardo dall'arresto di almeno 15 minuti o a una temperatura interna del motore inferiore di 20°C rispetto alla temperatura settata di allarme;
L'INTERVENTO DEL 2° ALLARME, CON ARRESTO DEL MOTORE, AVVIENE QUANDO :
 - C'è un sovraccarico
 - C'è uno scarso raffreddamento
 - Ci sono frequenti avviamenti

Con il motore avvolto :

- In PVC la massima temperatura di settaggio del secondo allarme potrà essere di 58°C
- In PE2+PA la massima temperatura di settaggio del secondo allarme potrà essere di 75°C.
Tale dispositivo potrà essere utilizzato anche per monitorare le temperature dei cuscinetti, dei lubrificanti, nei motori elettrici di superficie e nelle macchine operatrici in generale.
L'apparechiatura rispetta le norme di compatibilità elettromagnetica CEI EN-50081-2 e 50082-2.
Dimensioni : 48*96 mm DIN 43700
profondità: 130 mm.

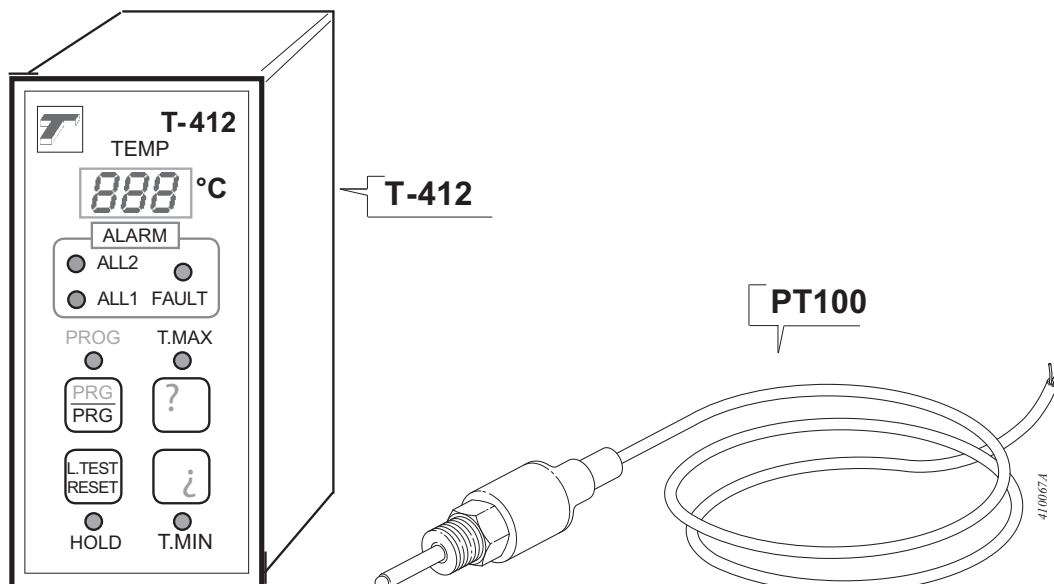

MEI = 0.4 for Multistage Submersible 2900rpm

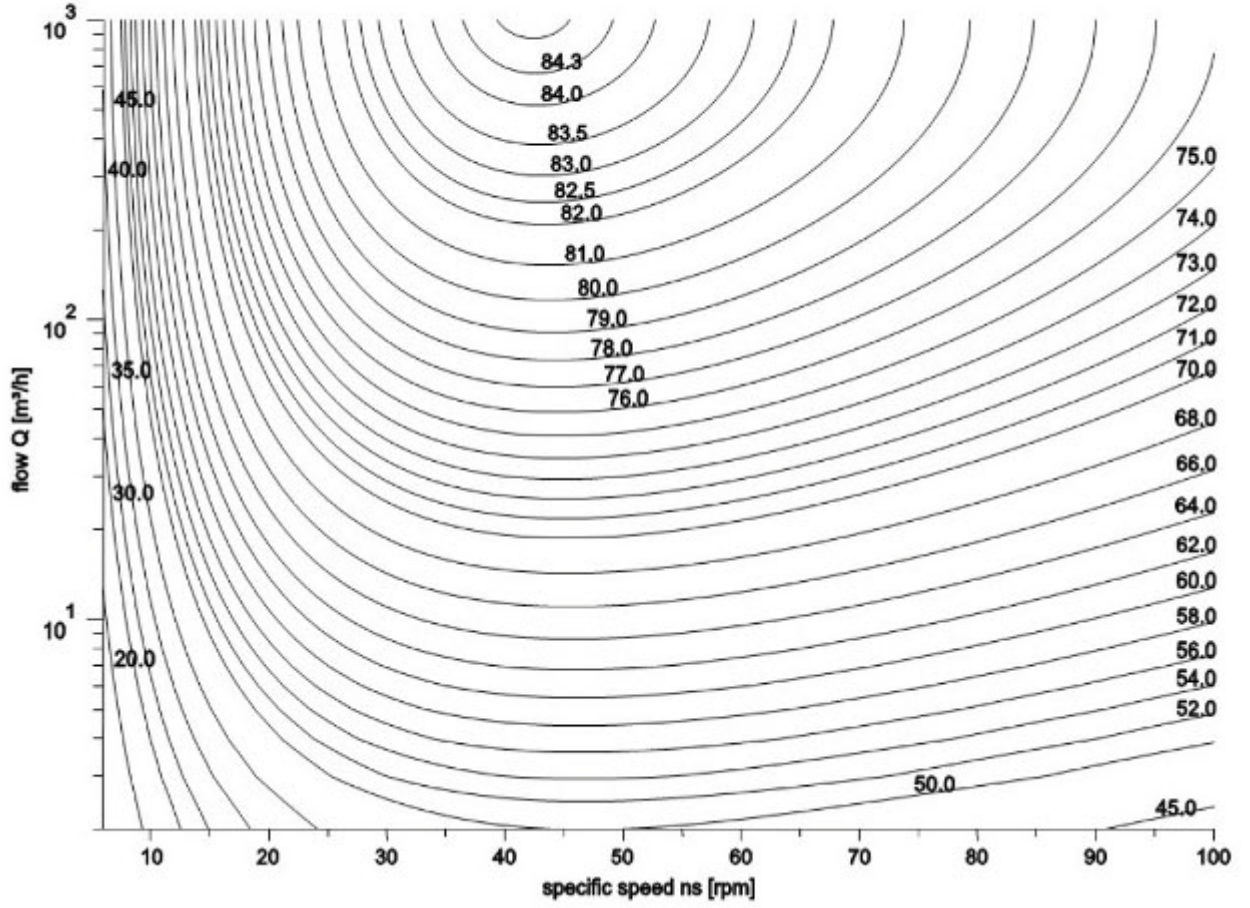

MEI = 0.7 for Multistage Submersible 2900 rpm

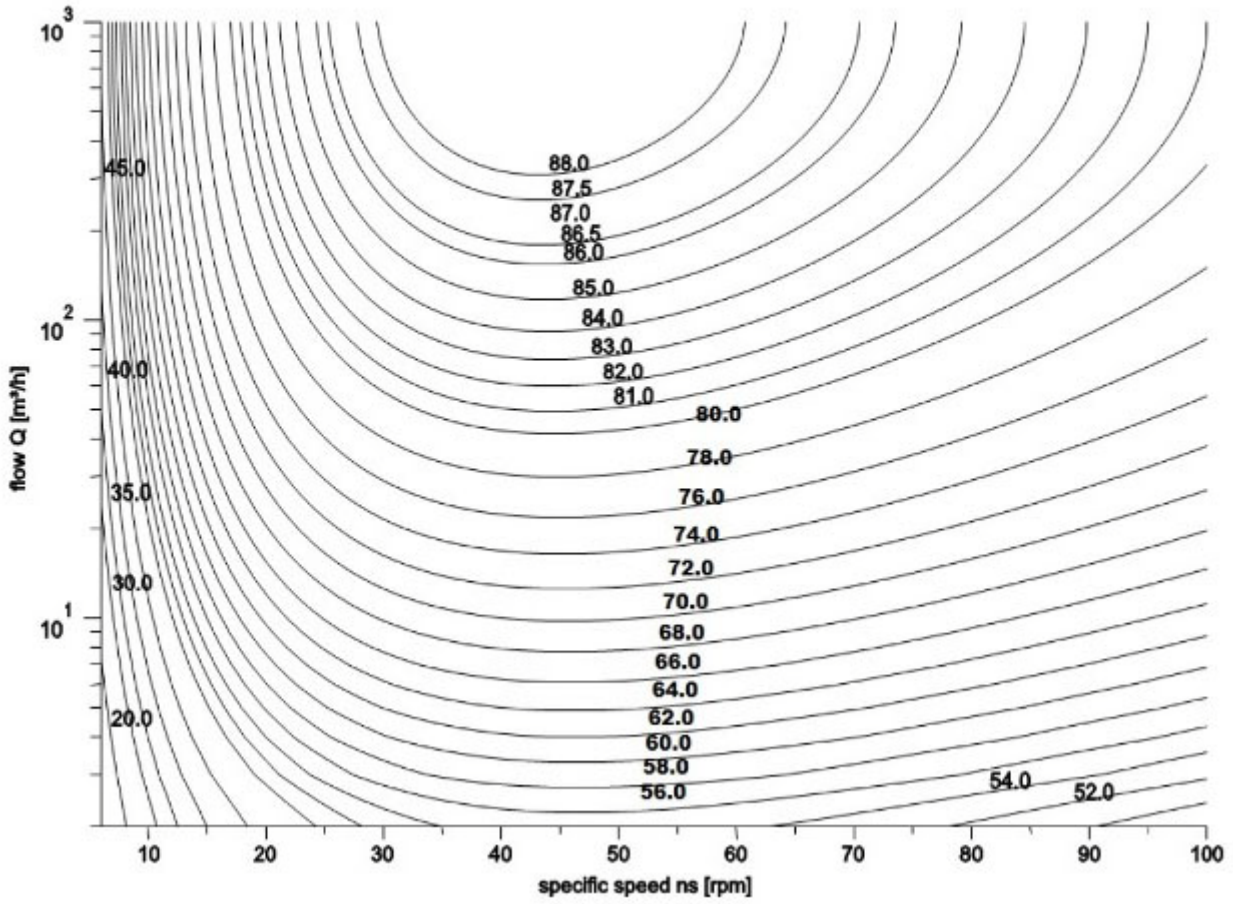

Caprari pumps are coated with WRAS approved paint

Les pompes Caprari utilisent des peintures certifiées WRAS.

Le pompe Caprari utilizzano vernici certificate WRAS.

caprari

*The dimensions have an indicative value. Executive drawing will be supplied on request upon order.
CAPRARI S.p.A. reserves the right to make changes to improve its products at any time and without any notice*

*Les dimensions sont fournies à titre indicatif. Le plan bon pour exécution sera fourni sur demande au moment de la commande.
CAPRARI S.p.A. se réserve la faculté d'apporter des modifications visant à améliorer ses propres produits à tout moment et sans aucun préavis.*

**Le dimensioni hanno valore indicativo. Il disegno esecutivo sarà fornito su richiesta in fase d'ordine.
CAPRARI S.p.A. si riserva facoltà di apportare modifiche atte a migliorare i propri prodotti in qualsiasi momento e senza preavviso alcuno.**