

SEMISOM /50 - /65

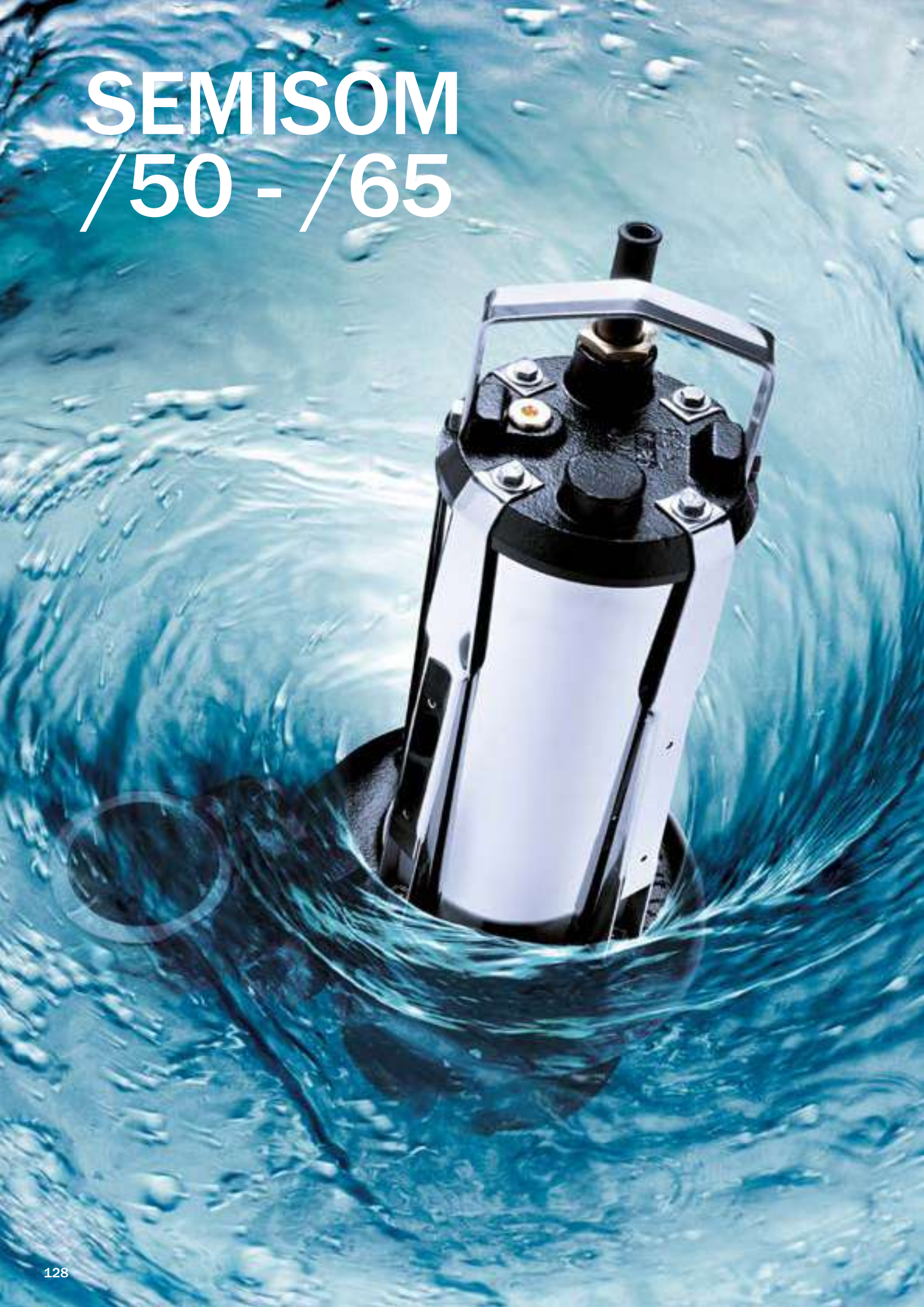

Electric submersible pumps SEMISOM /50 - /65 for sewage water



APPLICATION

Electric submersible pumps for installations in civil and industrial environments. Suitable to convey dirty, waste and sewage water also containing suspended solids whose size is up to 65 mm. They are recommended to transfer water, to drain tanks or flooded areas, to pump water coming from civil and industrial installations as well as the drainage of septic tanks. They can also be used to pump sewage keeping its biological process unchanged (4 pole version).

CHARACTERISTICS

IP rating	IP68
Duty	Continuous S1
Maximum immersion depth (m)	20
Maximum number of starts per hour	30
Maximum temperature of the liquid pumped (°C)	50
PH of the liquid pumped	6 - 10
Density of the liquid pumped (kg/dm ³)	<1,1
Suitable for inverter drive	Only three-phase versions

APPLICATION RANGE

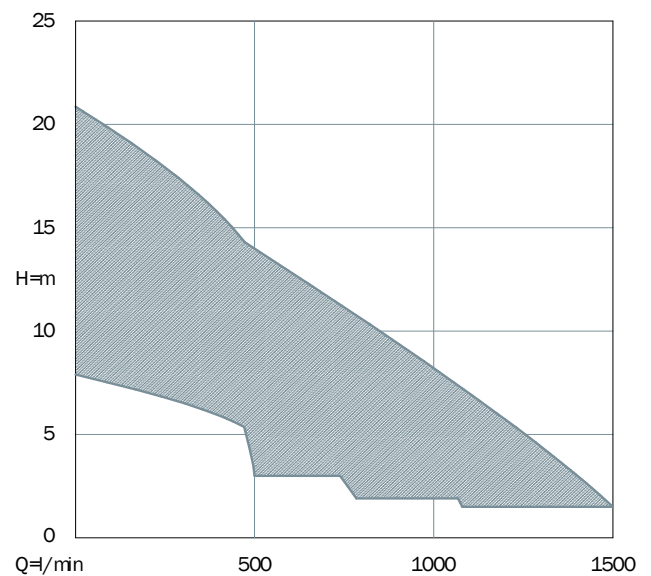

CONSTRUCTION

Coolant filled, asynchronous, rewindable electric AC motor with short circuit rotor. Insulation Class F. Windings with phase insulators to protect the motor from power peaks, as a guarantee of a highly-trustworthy product.

Resin-insulated cable kit to prevent penetration of water inside the motor

Shafts machined on ball bearings and mechanical seals location

Double mechanical seal with interposed oil chamber

MATERIALS

Tie rods, handle, motor casing, bolts and nuts	Stainless Steel AISI304
Shaft	Stainless Steel AISI420B
Cover and volute	Mechanical cast iron EN GJL-250
Impeller	Mechanical cast iron EN GJL-200
Mechanical seal	Silicon carbide and alumina
Seal ring	NBR rubber
Elastomers	NBR rubber
Cable	Neoprene H07RN8-F

Electric submersible pumps SEMISOM /50 - /65

for sewage water

PERFORMANCE DATA

Vortex Impeller	P2		1~230 V		3~400 V		Poles	Ø solid passage (mm)	Q		Flow												
	hp	kW	Max A	µF	Max A	m³/h			0	12	18	24	30	36	42	48	54	60	66	78	90		
									l/min	0	200	300	400	500	600	700	800	900	1000	1100	1300	1500	
	SEMISOM	500/50	1,5	1,1	9,2	40	3,3	2	50	H (m)	10	8,5	7,5	6	3								
	SEMISOM	800/50	2	1,5	11,4	45	4	2	50		11,5	10	9,5	8,5	7	4							
	SEMISOM	1100/65	3	2,2			6	2	65		13	11	9,5	8,5	7	5,5	4	2,5	1				
	SEMISOM	1300/65	4,5	3,4			8,1	2	65		18,5	16	14,5	13	11,5	10	8,5	7	5,5	3,5	2		
	SEMISOM	754/65	1,6	1,2	7,7	31,5	3,3	4	65		7,8	6,7	6,2	5,5	4,6	3,7	2,5						

Channel impeller	P2		1~230 V		3~400 V		Poles	Ø solid passage (mm)	Q		Flow											
	hp	kW	Max A	µF	Max A	m³/h			0	12	18	24	30	36	42	48	54	60	66	78	90	
									l/min	0	200	300	400	500	600	700	800	900	1000	1100	1300	1500
	SEMISOM	700/50	1,5	1,1	9,2	40	3,3	2	50	H (m)	14	11,5	10	8,5	7	5	3	1				
	SEMISOM	900/50	2	1,5	11,4	45	4	2	50		16	14	12,5	11,5	10	8	6,5	5	3	0,5		
	SEMISOM	1000/50	3	2,2			5,9	2	50		20,5	18	17	15,5	14	12	10,5	8,5	6	4	1,5	
	SEMISOM	1500/65	4,5	3,4			9	2	65		19,5	17,5	16,5	15,5	14,5	13,5	12	11	10	8,5	7	4,5

PERFORMANCE CURVES

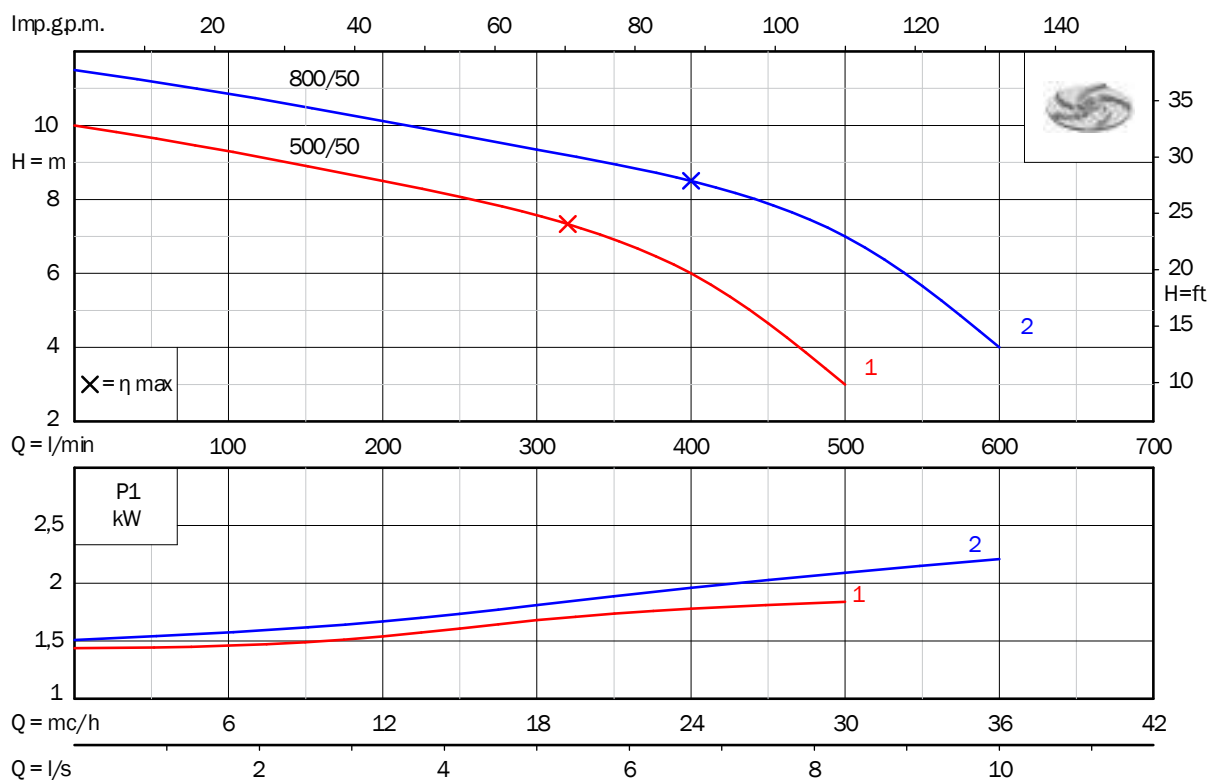

PERFORMANCE CURVES

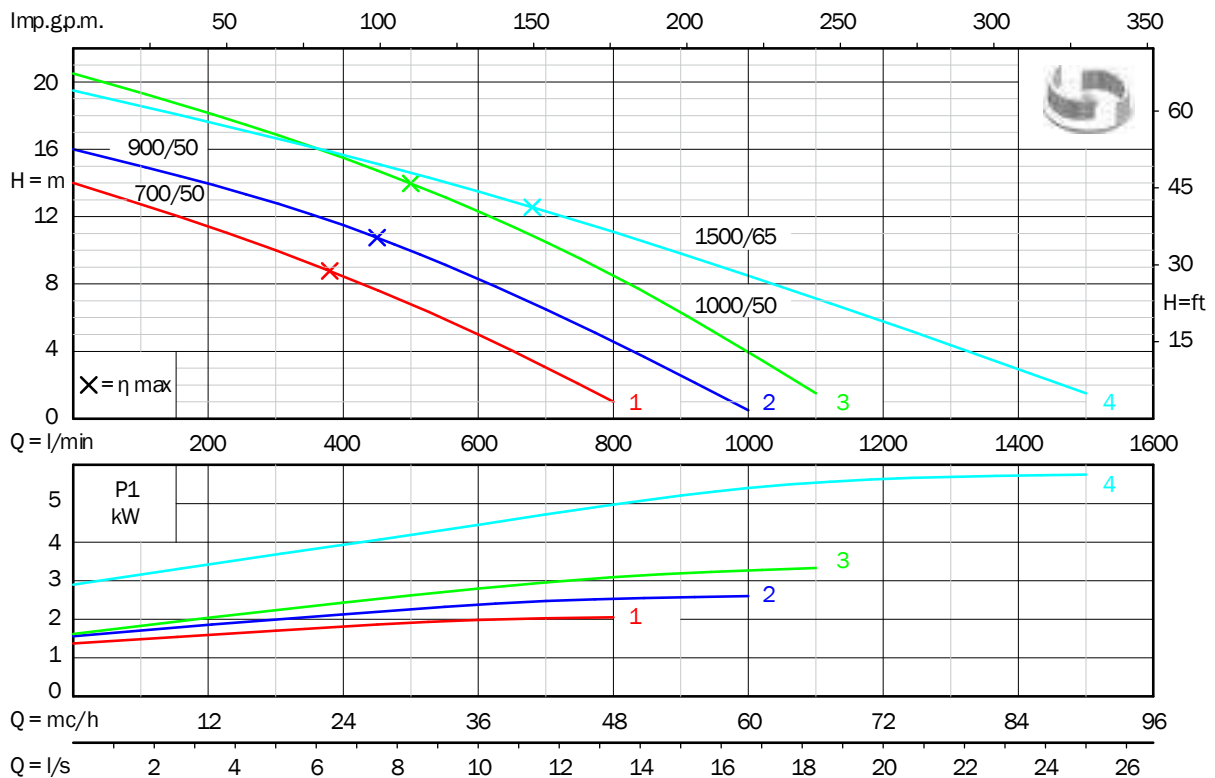
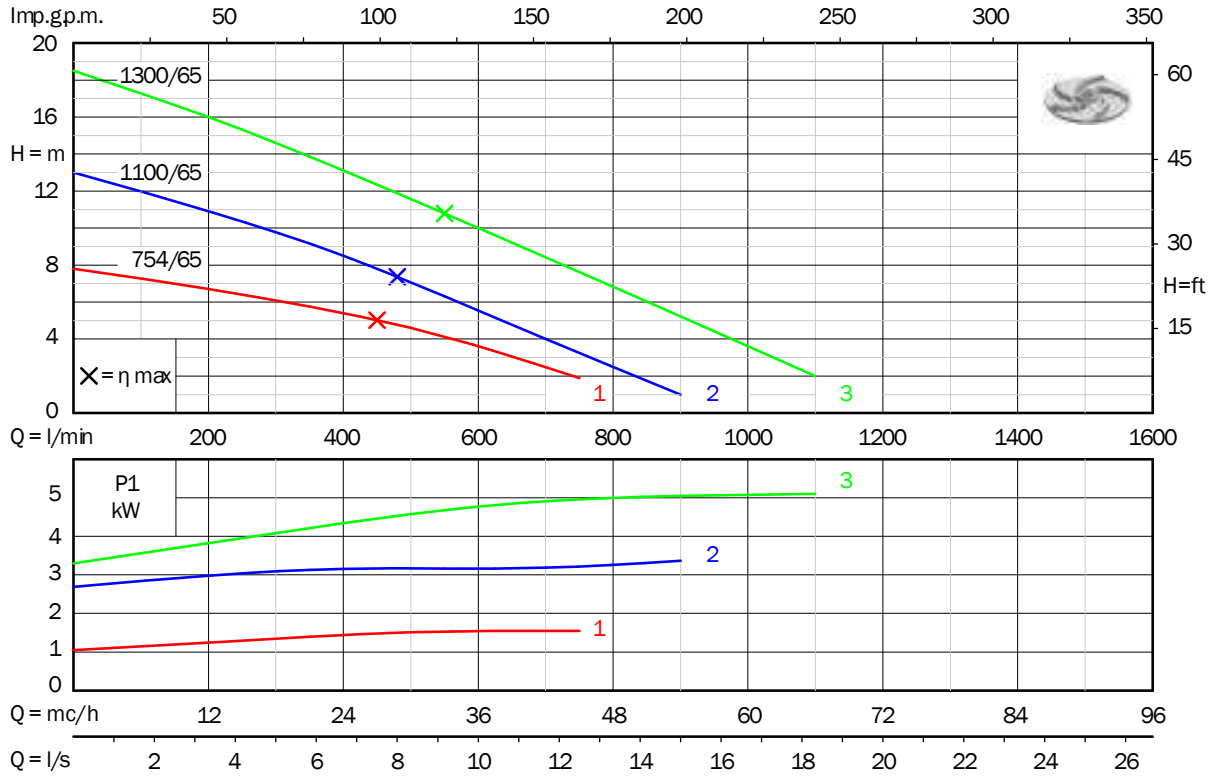

Electric submersible pumps SEMISOM /50

for sewage water

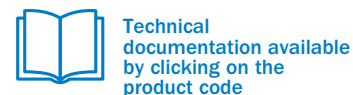

PERFORMANCE DATA 2 poles 50 Hz

Vortex Impeller	Code	Version		P2		P1		Max	Flow		Ø solid passage (mm)	DNM (GAS)	Dimensions (mm)				Weight
				hp	kW	kW	A		l/min	m			A	B	C	D	
	SM/50/500/1	230 V	1-phase	1,5	1,1	1,84	9,2	100 - 300 - 500	9,5 - 7,5 - 3	50	2"	518	70	354	254	32	
	SM/50/500+G/1	230 V	1-phase+float													32,3	
	ST/50/500/1	400 V	3-phase													1,63	3,3
SEMISOM 800/50	SM/50/800/1	230 V	1-phase	2	1,5	2,21	11,4	100 - 300 - 600	11 - 9,5 - 4	50	2"½	543	70	362	254	34,5	
	SM/50/800+G/1	230 V	1-phase+float													34,8	
	ST/50/800/1	400 V	3-phase													2,07	4

P1: Max. absorbed power - P2: Nominal power of the motor

PERFORMANCE DATA 2 poles 50 Hz

Channel impeller	Code	Version		P2		P1		Max	Flow		Ø solid passage (mm)	DNM (GAS)	Dimensions (mm)				Weight
				hp	kW	kW	A		l/min	m			A	B	C	D	
	SM/50/700/1	230 V	1-phase	1,5	1,1	2,05	9,2	100 - 400 - 800	13 - 8,5 - 1	50	2"	518	70	354	254	32,5	
	SM/50/700+G/1	230 V	1-phase+float													32,8	
	ST/50/700/1	400 V	3-phase													1,93	3,3
SEMISOM 900/50	SM/50/900/1	230 V	1-phase	2	1,5	2,6	11,4	100 - 500 - 1000	15 - 10 - 0,5	50	2"½	543	70	362	254	35	
	SM/50/900+G/1	230 V	1-phase+float													35,3	
	ST/50/900/1	400 V	3-phase													2,39	4
SEMISOM 1000/50	ST/50/1000/1	400 V	Trifase	3	2,2	3,33	5,9	100 - 500 - 1100	19,5 - 14 - 1,5	50	2"½	543	70	362	254	35	

P1: Max. absorbed power - P2: Nominal power of the motor

SUPPLIED WITH

10 meters power cable



Control box containing capacitor and illuminated thermal protector switch (single-phase versions)



OPTIONS

Version with thermic probe so to protect the motor from overheating (to be wired to protection and control panel type QT-MT - AM-AT)



UNI EN 1092-1
DN40 PN6

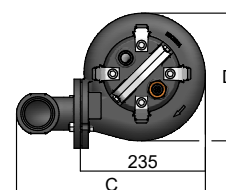
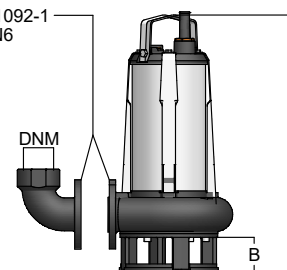

ACCESSORIES

Code	Description
04105046	Guide rail kit inlet flange UNI EN 1092-1 DN40 PN6 - discharge flange UNI EN 1092-1 DN65 PN40 (1"¼ guide poles not included) 

ILLUSTRATION OF AN INSTALLATION WITH GUIDE RAIL KIT



Electric submersible pumps SEMISOM /65

for sewage water

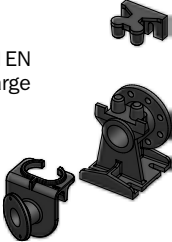
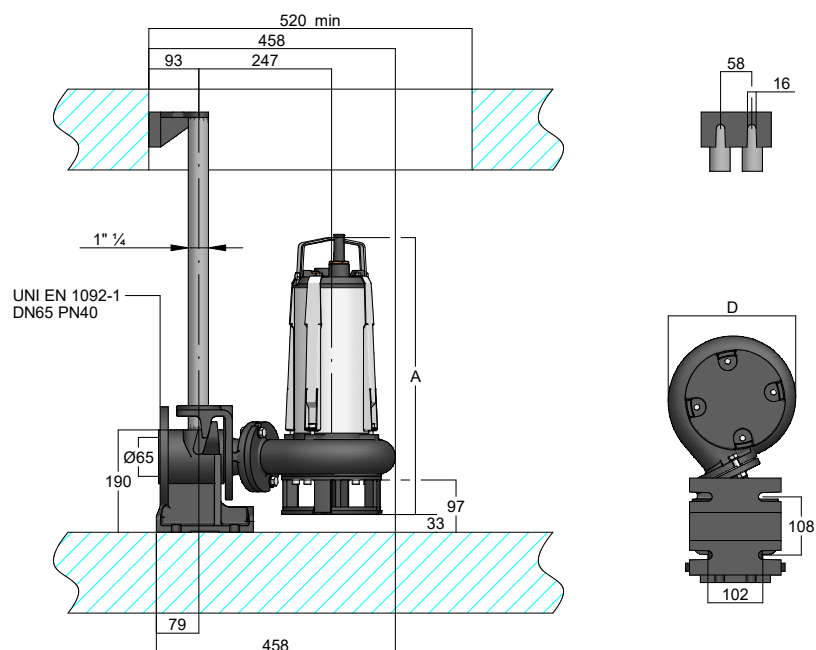

PERFORMANCE DATA 2 poles 50 Hz

Vortex Impeller 	Code	Version		P2		P1	Max	Flow		Ø solid passage (mm)	Ø outlet (mm)	Dimensions (mm)				Weight kg
				hp	kW	kW		A	l/min			m	A	B	C	
SEMISOM 1100/65	ST/65/1100/1	400 V	3-phase	3	2,2	3,37	6	100 - 500 - 900	12 - 7 - 1	65	65	584	65	417	222	40
SEMISOM 1300/65	ST/65/1300/1	400 V	3-phase	4,5	3,4	5,1	8,1	100 - 600 - 1100	17 - 10 - 2	65	65	609	65	417	222	42,5

P1: Max. absorbed power - P2: Nominal power of the motor

PERFORMANCE DATA 4 poles 50 Hz

Vortex Impeller 	Code	Version		P2		P1	Max	Flow		Ø solid passage (mm)	Ø outlet (mm)	Dimensions (mm)				Weight kg
				hp	kW	kW		A	l/min			m	A	B	C	
SEMISOM 754/65	SM/65/754/1	230 V	1-phase	1,6	1,2	1,55	7,7	100 - 400 - 750	7,3 - 5,5 - 1,9	65	65	569	65	417	222	38,5
	SM/65/754+G/1	230 V	1-phase+float			1,45	3,3									38,8
	ST/65/754/1	400 V	3-phase			38,5										

P1: Max. absorbed power - P2: Nominal power of the motor

PERFORMANCE DATA 2 poles 50 Hz

Channel impeller 	Code	Version		P2		P1	Max	Flow		Ø solid passage (mm)	Ø outlet (mm)	Dimensions (mm)				Weight kg
				hp	kW	kW		A	l/min			m	A	B	C	
SEMISOM 1500/65	ST/65/1500/1	400 V	3-phase	4,5	3,4	5,75	9	100 - 700 - 1500	18,5 - 12 - 1,5	65	65	609	65	417	222	44

P1: Max. absorbed power - P2: Nominal power of the motor

SUPPLIED WITH

10 meters power cable



Control box containing capacitor and illuminated thermal protector switch (single-phase versions)



OPTIONS

Version with thermic probe so to protect the motor from overheating (to be wired to protection and control panel type QT-MT - AM-AT)



UNI EN 1092-1
DN65 PN6

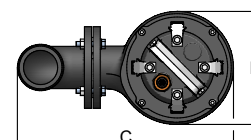
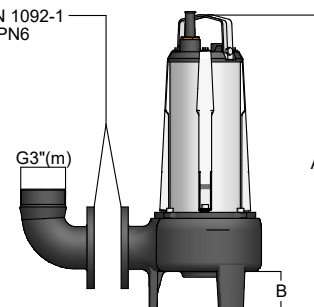

ACCESSORIES

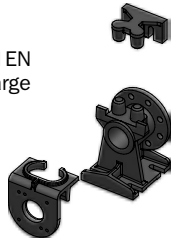
Code	Description
04105052	Guide rail kit inlet flange UNI EN 1092-1 DN65 PN6 - discharge flange UNI EN 1092-1 DN65 PN40 (1"¼ guide poles not included) 

ILLUSTRATION OF AN INSTALLATION WITH GUIDE RAIL KIT

